

The how-to magazine of electronics...

AN INTERTEC PUBLICATION

ELECTRONIC

Servicing & Technology

September 1988/\$2.50

Unusual lines in the picture • Electronics and automobiles

What do you know about...Four-terminal networks

**The new
breed of
multimeters**



Intermittents. We Hear You.

Introducing The Heavy-Duty DMM With An Audible Readout That Lets You Keep Both Eyes On The Job.

Intelligent design and solid construction make the new HD 150 Series the best DMMs in their class.

They're the latest in a distinguished line that began when Beckman Industrial pioneered heavy-duty DMMs with their distinctive yellow color. Many competitors have since imitated that color. As for imitating their performance, no one comes close.

The HD 150 Series attains new levels of excellence with a range of advanced features. They're waterproof. Drop proof.

Auto-ranging. Slim-styled for one-hand comfort and convenience. With auto-off to prolong battery life. Plus 2 fuses, PTC resistor and MOV for unsurpassed overload protection.

Audible readout. A "sound" reason to go with the HD 150 Series. With this unique feature on the HD 153, you measure parameters by listening to a continuous variable tone. As the parameter you measure rises or falls, the tone's frequency increases or decreases, accordingly. Use it for volts, amps, or ohms. It's ideal for peaking and nulling, too.

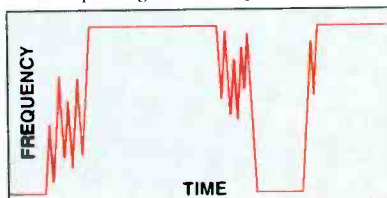

Intermittent alert. A key application of audible readout. The HD 153 pinpoints intermittents by emitting a "crackling" sound when they're detected. The response sounds in about 1 msec—far faster than the information appears on any DMM display.

Logic function.

The HD 153 detects TTL or CMOS logic pulses using standard test leads.

Easy to use.

The HD 150 Series lets you read the LCD even at wide angles. With the large rotary dial you select functions with one-handed (right or left) convenience. Auto-ranging speeds you to the right range. A tilt-stand and Skyhook let you set or hang the DMM almost anywhere.



Built tough to work hard. The HD 150 Series DMMs are so tightly sealed against water and grime that they're *guaranteed for five years* against contamination. And, because they're built so tough, they're guaranteed for two years against *any* damage (except abuse). Crashes, overloads, moisture, dust... you name it. The HD 150 Series can handle it all!

Listening is believing. For a hands-on demo, see your distributor now. Learn why the HD 150 Series is the soundest DMM value you'll see. Or hear.

Key Specifications

	HD 151	HD 152	HD 153
Auto-ranging	✓	✓	✓
Range Lock		✓	✓
Audible readout			✓
Tilt Stand and Skyhook™	Optional	Optional	Included
Logic pulse detector			✓
DC voltage accuracy	0.7%	0.5%	0.25%
10A range		✓	✓
Suggested list price	\$149.00	\$169.00	\$199.00



Beckman Industrial™

Beckman Industrial Corporation
Instrumentation Products Division
A Subsidiary of Emerson Electric Company
3883 Ruffin Road, San Diego, California 92123-1898
(619) 495-3200 • FAX: (619) 268-0172 • TLX: 249031

*In Service
Instruments,
We're The One.*

© 1988 Beckman Industrial Corporation
Specifications subject to change without notice.
Valox is a registered trademark of General Electric Corporation.

Circle (1) on Reply Card

Chemswab™
IPA Saturated
Foam Swab

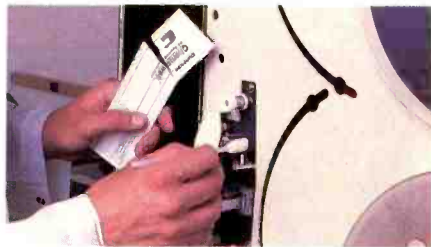

Freez-It® - 65°F
Variable Control
Tracks Intermittents

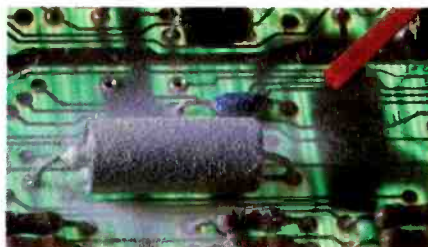

Ultrajet® Dusters
Precision Filtered
to < 0.2 Microns

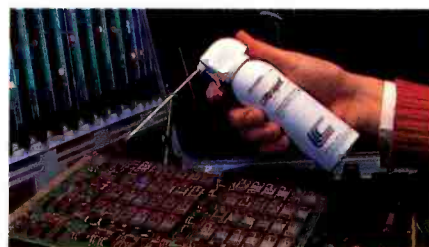

Flux-Off®
CO₂ Propelled
No Scrubbing



Konform®
UL Listed
UV Detectable



Gold Guard™
Preserves Precious
Metal Contacts



Chempad™
IPA Saturated
Cleaning Pad



Chem-Wik® Lite
Desolders
50% Faster



Twillwipes™
Textured Cotton
Lint Free



Performance you can count on.

The electronic service industry's most popular chemicals and cleaning products for over 30 years.
Call or write today for a free catalog, samples or technical assistance.



Chemtronics

Chemtronics Inc. 681 Old Willets Path, Hauppauge, NY 11788 800-645-5244 in NY 516-582-3322

Circle (3) on Reply Card



page 14

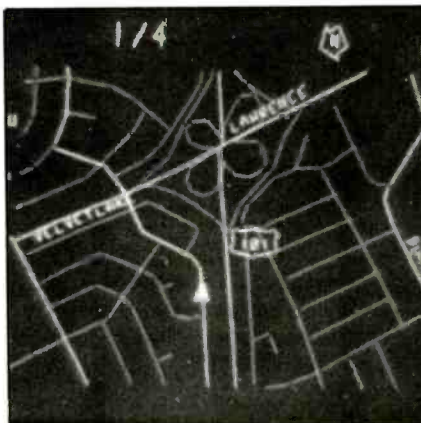

page 26

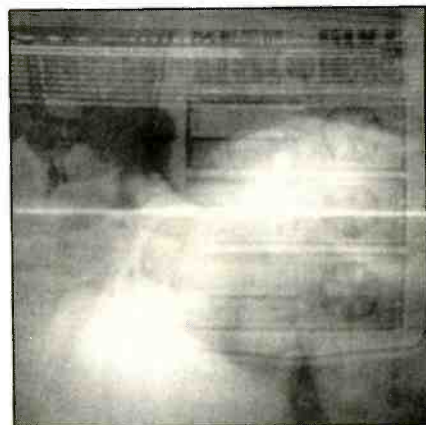

page 49

FEATURES

14 The new breed of multimeters

By Conrad Persson

Although the multimeter isn't the only piece of test equipment an electronics servicer is likely to have on the bench, this basic device is important—it tests for the three variables in that basic relationship, $E=IR$, and can isolate many faults in electronics circuitry. Whether you want to go basic or try out the latest in high-tech gizmos, you've got a lot of new features to choose from.

26 Electronics and automobiles: A revolution in the making

By Mike Ergo

If you've always wanted to be part of a revolution, now's your chance, because one of the newest technological revolutions is taking place in electronics—automobile electronics. If you think today's automobiles are sophisticated, with their power window and door locks, computer-controlled engine performance, fuel-injected engines and elaborate dashboard instruments, try to imagine what

tomorrow will bring: camless engines, electronically controlled 4-wheel drive and 4-wheel steering, voice-activated functions and navigation systems. Welcome to the new frontier!

49 Unusual lines in the picture

By Homer L. Davidson, CET

No one wants lines running through a TV picture, and with transistorized TVs, you don't just get a Barkhausen line or a drive line, you get a whole array of *unusual* lines. Twice the fun in troubleshooting, you might think. But—surprise!—these lines can actually help the servicer zero in on the problem components. These unusual lines often form recognizable patterns for certain defects. Finding the defect is often just a matter of learning to read the lines.

35 Profax

58 What do you know about electronics?

Four-terminal networks

64 Products

68 Video Corner

Elements of video optics—Part II

70 Audio Corner

More about decibels

72 Computer Corner

Interfacing computers to the analog world—Part IV

74 Readers' Exchange

76 Advertisers' Index

DEPARTMENTS

4 Editorial

6 Troubleshooting tips

10 Test your electronics knowledge

21 Books

24 Technology

Computer-aided design tool for microchips

ON THE COVER

The electronics servicer can now choose among a wide array of multimeters, from the simple hand-held, credit card-sized meter to the latest ruggedized, hands-free DMM with auto-ranging and tone generation. There is a multimeter for every application and every pocket-book, and with all those new features and functions, the servicer can count on finding the best meter for the job.

The how-to magazine of electronics...

ELECTRONIC
Servicing & Technology

There's so many features, You won't believe the price!

AMPROBE

Fused to 600 volts AC/DC for HIGH ENERGY PROTECTION to help protect instrument as well as user from mis-application!

- Accuracy to be found only in instruments costing much, much more
- 20 Industrial ranges: AC and DC amps, resistance and AC and DC voltage
- .1Ω resolution - great for checking motor windings
- 1 uA DC resolution - handy for oil burner applications
- Safety leads with replaceable lead tips
- Over-range indication
- Low battery indication
- Auto zeroes on all ranges
- Reversed polarity indication
- Accessories add 15KV AC/DC and temperature-measuring capability
- Color coded front panel with rotary switch
- Large, recessed 3½ digit LCD readout, yet a compact size and shape
- Rugged high impact molded case
- Standard banana jacks
- Battery hatch for quick and easy battery and fuse replacement

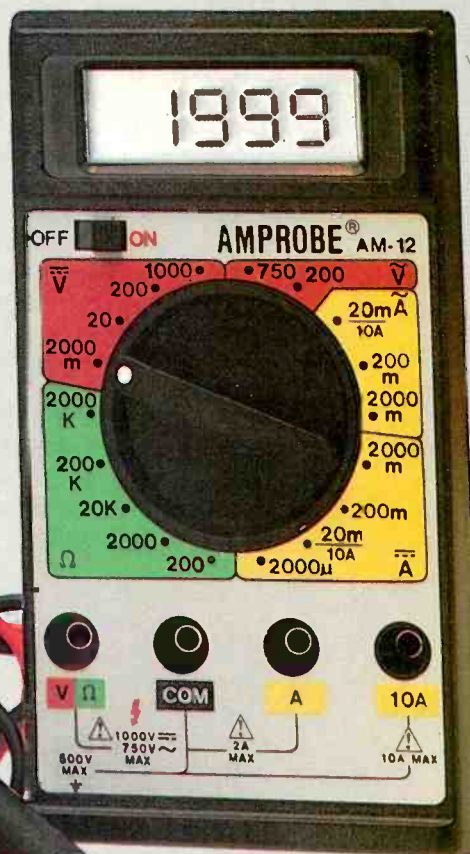

**Model
AM-12
\$44.85**



AMPROBE INSTRUMENT®
DIVISION OF CORE INDUSTRIES INC. LYNBROOK, NEW YORK 11563
630 MERRICK ROAD, P.O. BOX 329
Area Code 516 593 5800 • TWX 5102258403 AMPROBE LYBK
ITT TLX 4971416 • EASYLINK 62685684
FAX 516-593-5682

**Only AMPROBE®
gives so much
for so little.**

Available in well over 100 Countries around the world.
Atlas Electronics in Canada.

Write for catalog AAD79 or visit your AMPROBE distributor today.

Circle (4) on Reply Card

Electronics without math?

As I write this, it's the day of the 1988 Major League Baseball Allstar Game. Tonight, as pitchers come up to the mound, the announcers will be throwing around such statistics as the number of games won and lost, the earned-run averages and other important pitching statistics.

At the same time, when Dave Winfield or George Brett or Wade Boggs steps up to the plate, the announcers will be spouting about the batting average, slugging percentage, number and percent of extra-base hits, and on and on about this particular batter. There will probably even be statistics about what this batter's average is against right-handed pitchers or southpaws.

And savvy baseball fans will sit in the stands or in their living rooms eating hot dogs, drinking beer and nodding knowingly about the importance of these statistics.

A lot of these same fans, who might be consumer electronics servicing technicians, will ask, when faced with an exposition on electronics, "Well, couldn't you explain it without the math?"

Starting in our August issue, Sam Wilson is writing a year-long series of articles on network theory, and, in answer to the requests from many people he's had as students in his various classes, he's trying to do it *without the math*. You have to watch out for Sam, though—he's sneaky, and he keeps slipping in the math.

The fact is, you can't explain electronics without the numbers any more than you can describe a game of baseball without the numbers. In baseball, besides the hitting, pitching and fielding statistics, there are the dimensions of the tools of the baseball player: the ball, bats and gloves must be very specific sizes. The dimensions of the playing field are precisely defined.

Or how about your relationship with your employer or employee? In most

cases, such a relationship is defined in very precise mathematical terms. The employee works for a specified number of hours per day, for a specific number of days during the week. For each of these hours, the employee usually earns a specified number of dollars, and a specified percentage of his pay is withheld for social security and for federal, state and perhaps local income taxes.

Mathematics is involved in almost everything we do: buying a house or a car and paying the phone, gas, electric or water bills are all based on some kind of mathematical calculations. Planning a trip will ordinarily involve many calculations, including the miles you plan to travel, the gas mileage of the car, the cost per gallon of gasoline at the time, anticipated tolls, the cost of hotels/motels/meals, the cost of activities and so on.

And some techs want to learn about electronics without the math.

Sam, I salute your attempt to describe electronics without math, and I hope you're able to do it. But I think those students of yours who have asked you to do the job without math have given you an impossible task.

The most fundamental relationship in electronics is $V = IR$, and that's a mathematical relationship. And the math gets more involved as you go along. I think we need to admit that math is fundamental to the business of electronics. We can try to make the math as understandable as possible, but electronics without math is just not possible.

(Oh, and Sam, I know that your occasional slips into using math in your exposition are your subtle way of telling the readers that understanding electronics without the math doesn't really make sense to you either, but I won't let anyone else in on your little secret.)

Nile Conrad Person



PHILIPS



Multiple Problems.

For microprocessor board troubleshooting and service, nothing expands your diagnostic capabilities — and simplifies your operation — like the new Fluke 90 Series.

This unique μ P board tester gives you a complete range of test functions:

- Bus Tests
- Memory Tests
- I/O Tests
- QuickTrace™ Probe Test, to automatically identify and display unknown nodes.



- In all, 16 different preprogrammed tests make the 90 Series a powerful stand-alone troubleshooting instrument.

Add the power of a PC.

Connect the 90 Series' RS-232 port to a PC or terminal and access advanced troubleshooting functions, such as Break-Point and Frame-Point capabilities, memory upload and download, plus external trigger functions. You can save both test sequences and results, building documentation on different boards as you go.

Designed for real-time testing.

The 90 Series consists of three units, each designed for one of the three most commonly used 8-bit processors (Z80, 6809 or 8085).

Each tester clips directly onto the microprocessor, including soldered-in processors. Power is supplied by the Unit Under Test. The UUT continues to operate while diagnostics are executed, so you can even locate intermittent problems.

Easy on the technician, easy on the budget.

The 90 Series is small enough (11" x 6" x 3") to find a home on every service bench. Test results are fast and presented in English. Each diagnostic function is selected from a simple-to-follow menu, which greatly reduces training time.

The Fluke 90 Series is ideal for service and repair operations, as well as engineering prototype testing and technician training. And it's ideally priced at \$1395 (suggested U.S. list), available from leading electronic distributors.

To find out more about the Fluke 90 Series, or the products that made Fluke the leader in emulative board testing, the 9000

One Solution.

Micro-System Troubleshooter or 9100 Digital Test System, call today at **1-800-44-FLUKE ext. 33.**

The Fluke 90 Series. A single instrument for a multitude of problems.



The 90 Series μ P Board Tester

John Fluke Mfg. Co., Inc., P.O. Box C9090, M/S 250C, Everett, WA 98206.
U.S.: 206-356-5400 CANADA: 416-890-7600
OTHER COUNTRIES: 206-356-5500

©Copyright 1987 John Fluke Mfg. Co., Inc. All rights reserved. Ad No. 1173-F90.



Circle (5) on Reply Card

Troubleshooting tips

Symptom: Incomplete vertical deflection, unstable horizontal hold, low-volume audio
Set ID: GE model 8-1304 (NF chassis)

This 13-inch General Electric color set had three problems: the picture (which was reasonably good with adequate color) did not fill the screen vertically, the horizontal hold was very unstable and the audio level was low even with the volume control turned all the way up.

Because no Photofact listing existed for this set, I ordered the service information package from the GE (now RCA) publications department in Louisville, KY. When this package arrived, I began troubleshooting. I assumed (quite wrongly as I found out later) that each problem had its own cause. I started by completely checking out the vertical sweep circuitry. I installed new output transistors, but they had no effect on the height of the picture. I then replaced several key electrolytic capacitors, but there was still no change.

Next, I reasoned (because the horizontal was unstable) that the vertical/horizontal IC could be defective. Installation of a new one had no effect on the problem.

Feeling very disgusted, I turned my attention to the low level of audio. I installed new output transistors and

replaced key electrolytic capacitors and an IC, but there was no effect in the audio circuitry either. The volume remained low.

Having spent about three hours without any progress, I put the set aside until the next day. The following morning, I sat down and went over the schematic diagram again. What was I overlooking? Could all of these symptoms have a common cause? Once I started looking at the problem from this perspective, the light dawned as I was studying the schematic area showing the flyback circuitry, in particular the 12V and 15.5V supply voltages developed by sweep rectification. For some reason, I had completely overlooked this circuitry. A quick measurement of these voltages showed 5V and 8V, respectively. I turned the set off and did some resistance checks. The reading I got for R₄₄₃ (connected directly to flyback pin 2) was 25Ω. This resistor should have read 5.1Ω.

A new R₄₄₃ eliminated all three problems and restored the set to normal working condition. I was so upset with myself for having overlooked this circuitry that I made up a small sign and taped it to my bench: "Don't forget to check *all* voltages, especially those developed by sweep rectification."

George Marechek
 Cheverly, MD

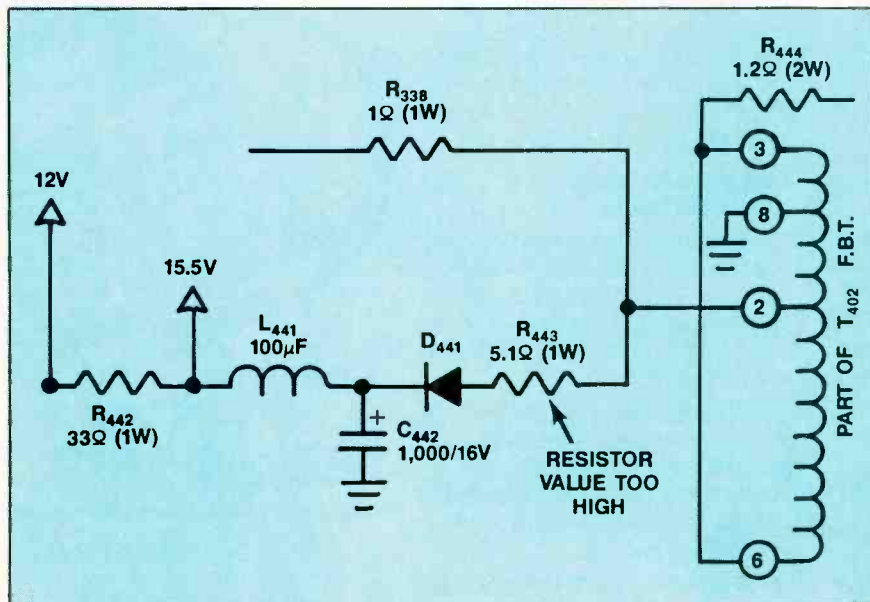

Figure 1. A new R443 eliminated three problems that appeared to be separate: incomplete vertical deflection, unstable horizontal hold and low-volume audio.

The how-to magazine of electronics...

ELECTRONIC

Service & Technology

Electronic Servicing & Technology is the "how-to" magazine for technicians who service consumer electronics equipment. This includes service technicians, field service personnel and avid servicing enthusiasts who repair and maintain audio, video, computer and other consumer electronics equipment.

EDITORIAL

Nils Conrad Persson, *Editor*
 Carl Babcoke, *Consumer Servicing Consultant*
 Tom Cook, *Senior Managing Editor*
 Alisa Carter, *Associate Editor*
 Kathy Mickelson, *Editorial Assistant*
 James McWard, *Editorial Assistant*

CONSULTING EDITORS

Homer L. Davidson, *TV Servicing Consultant*
 Christopher H. Fenton, *Circuit Fabrication Consultant*
 Victor Meeldijk, *Components Consultant*
 Kirk G. Vistain, *Audio Consultant*
 Sam Wilson, *Electronics Theory Consultant*

ART

Kevin Callahan, *Creative Director*
 Barbara Miles, *Graphic Designer*

BUSINESS

Cameron Bishop, *Group Vice President*
 Eric Jacobson, *Publisher*
 Greg Garrison, *Sales Manager*
 Stephanie Hanaway, *Promotions Manager*
 Kelly Hawthorne, *Promotions Coordinator*
 Dee Unger, *Advertising Business Manager*
 Catherine Grawe, *Advertising Coordinator*

ADVERTISING

Regional advertising sales offices are listed in classified pages.

ADMINISTRATION

R.J. Hancock, *President*
 Doug Reimer, *Circulation Vice President*
 Jane J. Powell, *Circulation Director*
 Jo Ann DeSmet, *Fulfillment Manager*
 Barbara Clare, *Reader Correspondent*



Member, Audit Bureau
 of Circulation



Member, American
 Business Press



Member, Electronic
 Servicing Dealers
 Association

CORRESPONDENCE

Editorial, advertising and circulation correspondence should be addressed to: P.O. Box 12901, Overland Park, KS 66212-9981 (a suburb of Kansas City, MO); 913-888-4664. Home office fax: 913-888-7243. Home office telex: 42-4156 INTERTEC DLPK

SUBSCRIPTION PRICES: one year, \$19.49; two years, \$32.98 in the USA and its possessions. Foreign countries: one year, \$23.49; two years, \$36.98. Single copy price: \$2.50; back copies, \$3.00. Adjustment necessitated by subscription termination to single copy rate. Allow 6 to 8 weeks for new subscriptions.

PHOTOCOPY RIGHTS: Permission to photocopy for internal or personal use is granted by Intertec Publishing Corp. for libraries and others registered with Copyright Clearance Center (CCC), provided the base fee of \$2 per copy of article is paid directly to CCC, 21 Congress St., Salem, MA 01970. Special requests should be addressed to Eric Jacobson, publisher. ISSN 0278-9922 \$2.00 + 0.00

Electronic Servicing & Technology (ISSN 0278-9922) is published monthly for \$19.49 per year by Intertec Publishing Corp., 9221 Quivira Road, Overland Park, KS 66215. Second-class postage paid at Shawnee Mission, KS and additional mailing offices. POSTMASTER: Send address changes to ELECTRONIC SERVICING & TECHNOLOGY, P.O. Box 12960, Overland Park, KS 66212.

©1988 All rights reserved.



Put them to the test

Mini-Meters with Maxi-Specs

5" L x 2 3/4" W x 1 1/2" H 5 1/4" L x 2 1/2" W x 7/8" H 5 3/4" L x 2 1/2" W x 1 1/4" H

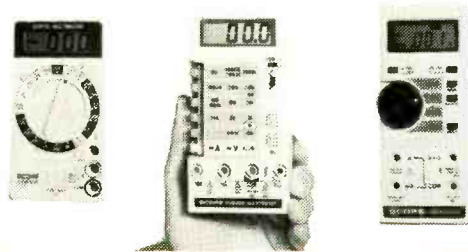

SCOPE 3 1/2 Digit LCD Meter

- 0.5% Accuracy • DC Voltage • AC Voltage • DC Current • Resistance • Diode Test • Battery Life 300 Hrs. • Overload Protection: DC 500V, AC 350V, ohms 250V DC/AC.

Model DVM-630
Our Price **\$2995**
Zippered carrying case CC-30 \$4.50

NEW! SCOPE 3 1/2 Digit, LCD 8 Function w/ Transistor Tester

- 0.5% Accuracy • Audible continuity and diode test • 10 Amp measurement • Resistance • DC/AC Voltage.

Model DVM-632
Reg. \$60.00
Our Price **\$4495**
Zippered carrying case CC-30 \$4.50

SCOPE 3 1/2 Digit LCD w/ Autoranging

- 0.5% Accuracy • Auto/Manual range selection • DC Voltage • AC Voltage • AC Current • DC Current • Resistance.

Special
Model DVM-631
Our Price **\$4995**
Deluxe carrying case CA-92 \$9.95

SCOPE Digital Capacitance Meter

.1 pf to 2000 μ f



- Digital LCD display • LSI-circuit • High accuracy: 100 PPM 0.5% • Broad test range • Fast sampling time • Capacitor discharge protection • Compact, light-weight design • One-hand operation.

Model DCM-602
Our Price **\$5995**

SCOPE Digital Multimeters

- Overload protection • Auto-decimal LCD readout • Polarity indication • 300 hr. 9V battery life • Low battery indicator • .5% DC accuracy

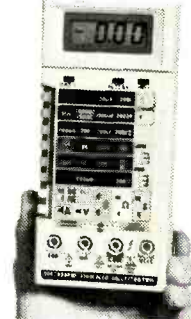

- 8 Functions, 37 Ranges including Transistor and Capacitance measurements

Model DVM-636
Our Price **\$6750**

- 11 Function, 38 ranges including Logic Level Detector, Audible and Visual Continuity, Capacitance and Conductance measurements

Model DVM-638
Our Price **\$8750**

CA-92 Deluxe Padded Case for DVM meters \$9.95
TL-216 Transistor and Capacitance Test Leads \$9.90

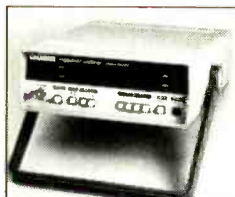

NEW! SCOPE Frequency Counters

- 8-digit LED • Compact • light-weight • Automatic range and Hold function • High stability in reference oscillator.

Model FC-7011
100 MHz Our Price **\$14995**
Special
Model FC-7051
550 MHz Our Price **\$19995**



FORDHAM Frequency Counter

- 10 Hz - 150 MHz Range • 7-digit LED display • VHF/HF selection • Gate time 1 sec., 5 sec. • ± 1 count accuracy.

Model FC-150
Our Price **\$13990**

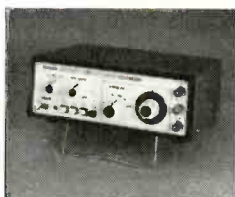

NEW FORDHAM Function Generator

- 0.5 Hz - 500 KHz in 6 ranges • Sine, square & triangle wave forms • VCA and VCF inputs • Accuracy $\pm 5\%$ of full scale.

Model FG-202
Our Price **\$14990**



FORDHAM Signal Tracer/Injector

- Easy to operate • VU meter • Two LED mode indicators • 1 KHz test tone • 8 ohm speaker • Test leads.

Model SE-610
Our Price **\$11990**



FORDHAM LCR Bridge Meter

- Fully transistorized • 1 KHz signal generator • Measures resistance, inductance, capacitance • High mechanical and electrical stability • Battery operated.

Model LC-340
Our Price **\$14995**



B&K Precision 20 MHz Dual Trace

- Dual/Single trace operation • 1 mV/div sensitivity • Auto/Normal triggered sweep operation with AC, TVH, TVV and Line coupling • Calibrated 18 step time base with IOX magnifier.

Model 2120
Our Price **\$39995**



FORDHAM Sweep Function Generator

- Frequency range 0.2 Hz to 2 MHz • Sine, triangle, square, pulse TTL, wave forms • Frequency accuracy $\pm 5\%$ of length scale • Test leads included.

Model FG-801
Our Price **\$21995**



SCOPE 4 1/2 Digit Bench Digital Multimeter

- 4 1/2 Digit LCD • Automatic (-) negative polarity • Six 1.5V "D" size batteries • Low battery indication • Overload protection • Test lead set, batteries, spare fuse incl.

Model DVM-6005
Our Price **\$21995**

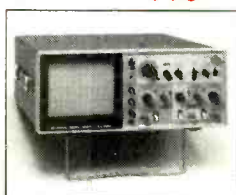

Hitachi 35 MHz Dual Trace Oscilloscope

- Frequency bandwidth DC to 35 MHz • 6 inch CRT with % calibrations • Autofocus • Scale illumination and photographic bezel • Light-weight, compact • Probes incl.

Model V-355
Our Price **\$59995**



SCOPE Pocket Sized Audio Signal Generator

- Sine/square wave patterns • 20 Hz to 150 KHz • Battery operation • Freq. accuracy $\pm 3\%$ or less • Output 1.2V rms max. (no load) • Low battery indicator • Test leads / 9V battery incl.

Model RC-555
Our Price **\$5995**

Telephone Orders Now!

ASK FOR FREE CATALOG. Money orders, checks accepted. C.O.D.'s require 25% deposit

Fordham

260 Motor Parkway, Hauppauge, NY 11788

Mon. - Fri. 8 a.m. - 6:30 p.m. EST. Sat. & Sun. 9 a.m. - 3 p.m. EST

Toll Free **800-645-9518**
In NY State 800-832-1446

Service & Shipping Charge Schedule Continental U.S.A.

FOR ORDERS	ADD
\$25-50	\$4.50
\$51-100	\$5.50
\$101-200	\$7.00
\$201-300	\$8.00
\$301-400	\$8.00
\$401-500	\$10.00
\$501-750	\$12.50
\$751-1000	\$15.00
\$1001-1,250	\$17.50
\$1,251-1,500	\$20.00
\$1,501-2000	\$25.00
\$2,001 and Up	\$30.00

An affordable portable is

Price/Bandwidth

\$4995 100 MHz 2230 DSO, 20 MS/s, 4K Record Length, 100 ns Glitch Capture, Cursors, CRT Readout, GPIB or RS-232-C Option

\$3995 60 MHz 2221 DSO, 20 MS/s, 4K Record Length, 100 ns Glitch Capture, Cursors, CRT Readout, GPIB or RS-232-C Option

\$2995 60 MHz 2220 DSO, 20 MS/s, 4K Record Length, 100 ns Glitch Capture, GPIB or RS-232-C Option

\$2995 100 MHz 2236 Two Channel, Counter/Timer/DMM, Dual Time Base

\$2395 100 MHz 2246A Four Channel, Store/Recall of 20 Front Panel Setups, Auto Setup, Smart Cursors,TM Dual Time Base

\$2395 50 MHz 2210 DSO, 20 MS/s Sample Rate, 4K Record Length

\$1795 100 MHz 2245A Four Channel, Auto Setup, Cursors, Dual Time Base

\$1595 100 MHz 2235 Two Channel, Dual Time Base

\$1095 50 MHz 2225 Two Channel, Horizontal Magnification (x5, x10, x50)

\$695 20 MHz 2205 Two Channel

*Digital Storage Oscilloscope

Check the prices and performance. You'll find the best measure of both in Tek 2200 Series Oscilloscopes. Ten scopes with bandwidths ranging from 20 to 100 MHz. Two and four channels. Analog and digital. And prices starting at just \$695.

Select for such features as automatic setup, time and voltage cursors, built-in DMM functions and dual analog/digital capabilities at the push of a button.

These are scopes you'll appreciate for their well-proven reliability, achieved through simplified, practical internal design. They come complete with probes and comprehensive Tek warranty that includes the CRT.

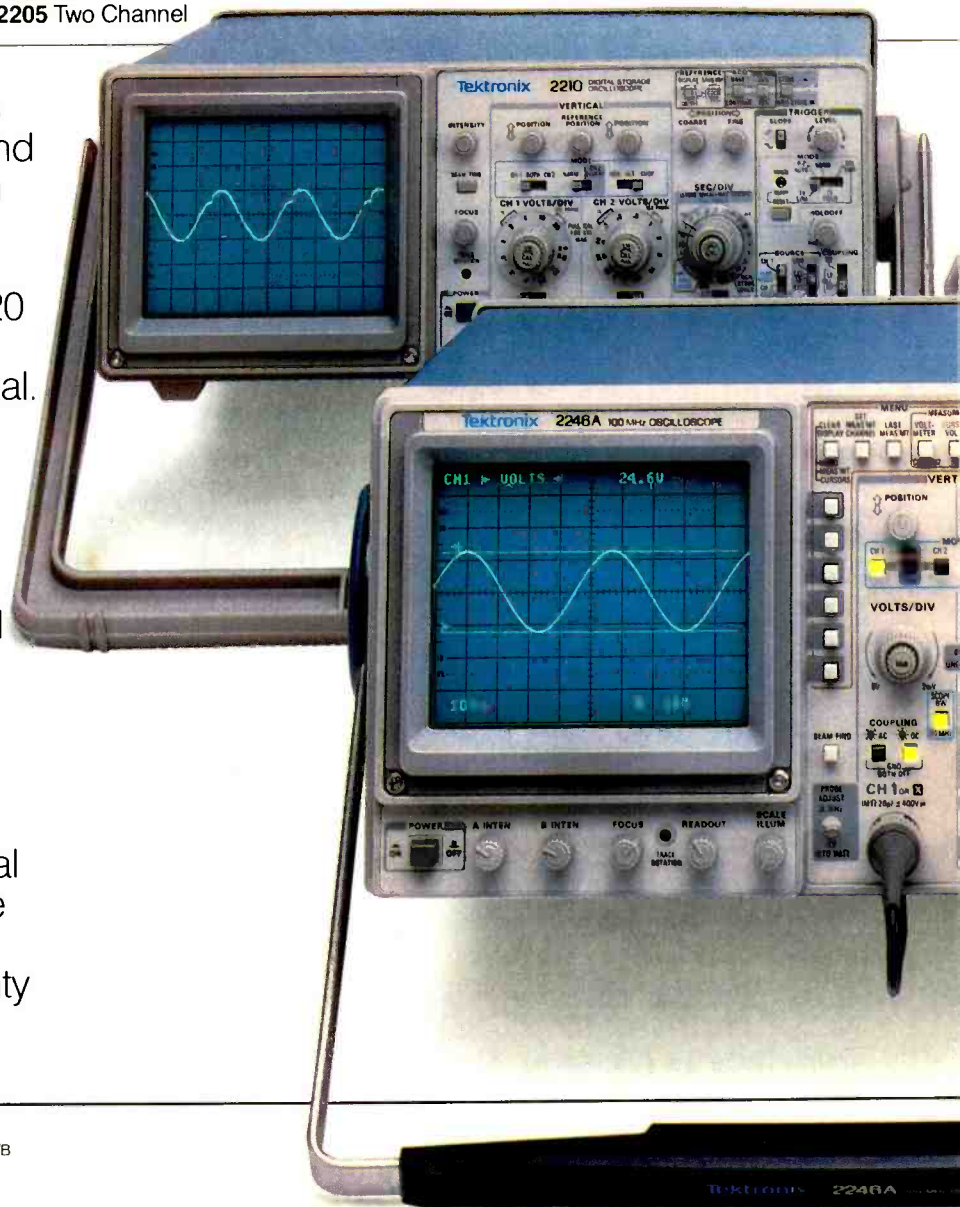

right within your range.

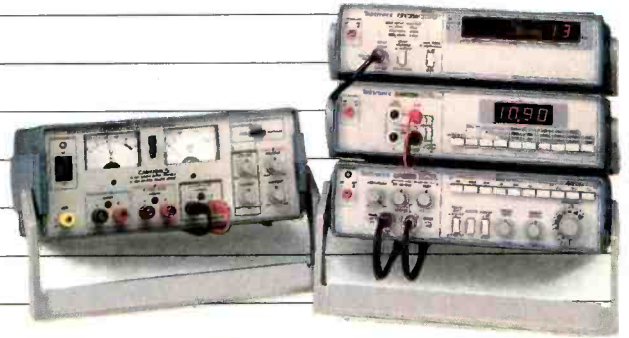

Industrial-quality test instrumentation starting at \$295.

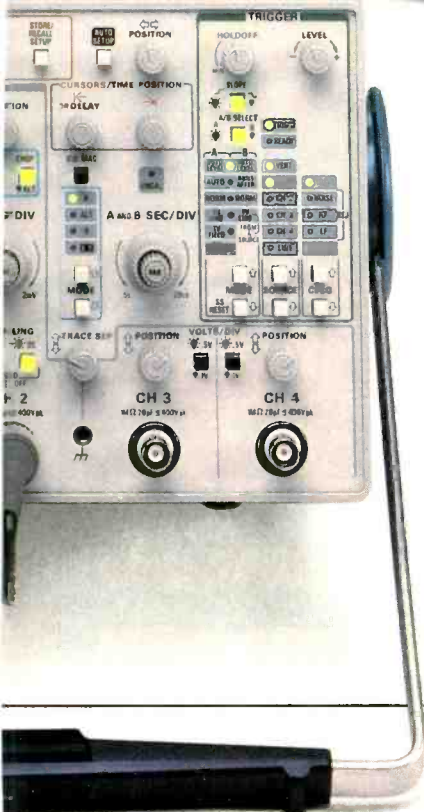
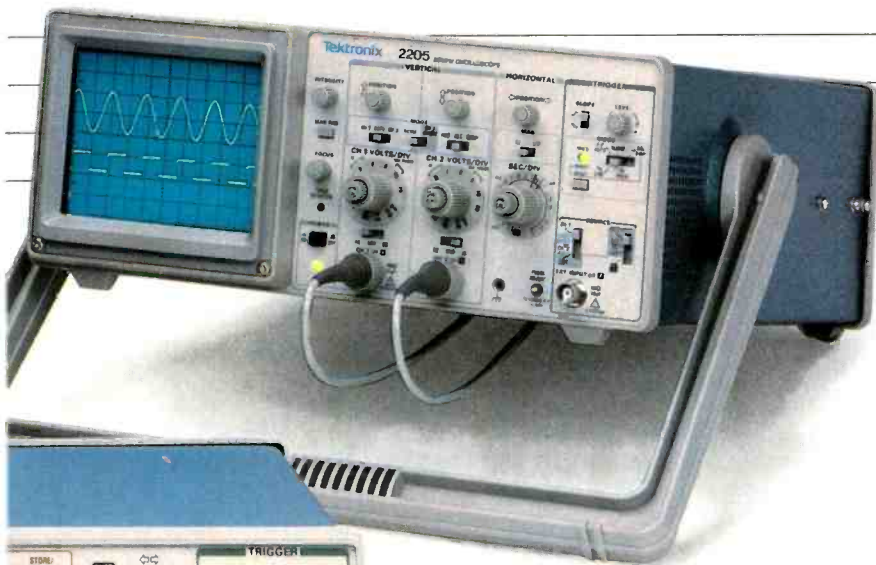

Ask those who own, use and rely on one—on the bench or in the field. There's just no substitute for genuine Tek quality. At any price. And at these prices, all the better.

Order one to go. Ask your Tek representative to set up a demo. Or call Tek direct. No need to settle for less when there's a top quality Tek portable with performance and price right within your range.

For easy ordering or more information, call Tek direct:

1-800-426-2200



Tektronix
COMMITTED TO EXCELLENCE

Circle (7) on Reply Card

Test your electronics knowledge

By Sam Wilson, CET

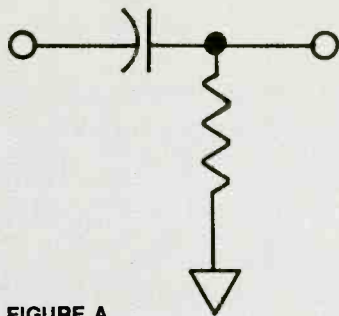

FIGURE A

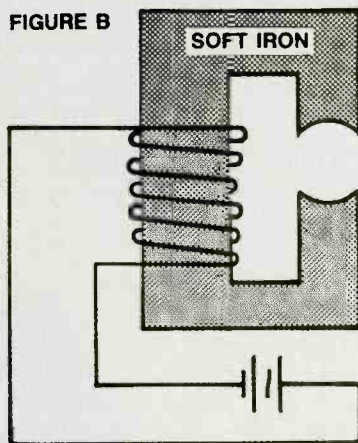

FIGURE B

Only super techs can expect to get a grade better than 40% on this test!

1. In computer language, what do the letters in the word BASIC stand for?

2. Both attenuators and pads are used for matching impedances. Which of these is variable?

- A. pads
- B. attenuators
- C. either or both
- D. neither is ever variable

3. Now that we're on the subject of pads, what is the attenuation of two pads—each providing a 6dB loss—connected in tandem?

4. Which of the following bridge circuits is best for measuring a high value of inductance?

- A. Hay bridge
- B. Wein bridge
- C. Maxwell bridge
- D. Schering bridge

5. Call up your knowledge of constant-k low-pass filters. How is the value of k determined?

- 6. Figure A shows
 - A. a differentiating circuit.
 - B. an FM de-emphasis circuit.
 - C. Both choices are correct.
 - D. Neither choice is correct.

7. In Figure B, the north pole of the electromagnet is

- A. at the top.
- B. at the bottom.

8. Three signals recorded on a VCR tape are: audio, video and _____.

9. In the TTL logic family, a logic high is a voltage above _____ and a logic low is a voltage below _____.

10. A very useful test instrument has the initials DSO. What do these initials stand for?

Wilson is the electronics theory consultant for ES&T.

Answers are on page 67.



PHILIPS

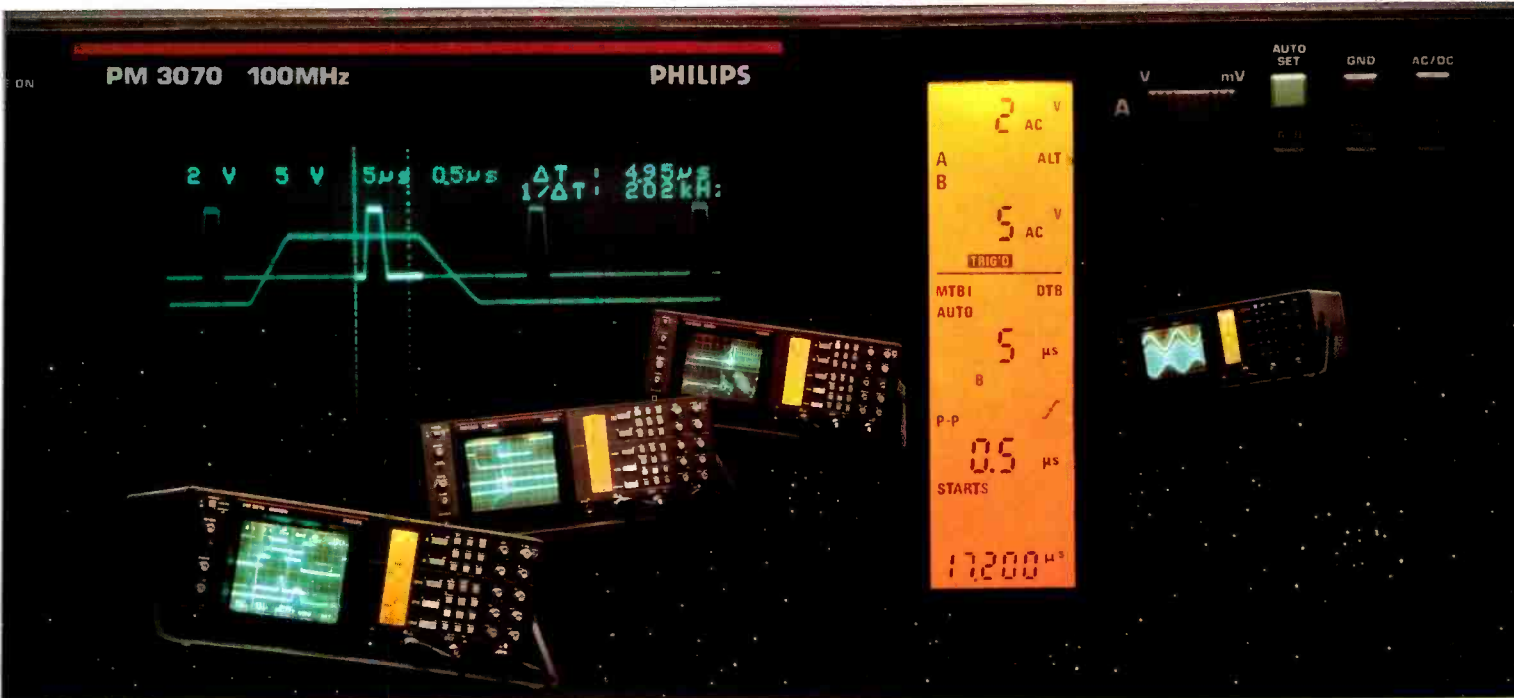

Introducing a whole new way to look at oscilloscopes.

Operation that's instinctively, unbelievably clear. Information that's detailed, yet free of errors. And intelligence that will speed your work. Philips' micro-computer controlled medium-frequency Smart Series. They could change forever the way you look at oscilloscopes.

HIGH PERFORMANCE WITH A VIEW

- **LCD window.** Large digital indications note all selected functions, instrument settings and parameter values. Instantly. Precisely. With no mistakes. And right where you need them—next to the CRT. Not hidden in crowded frontpanels. Not wasting critical waveform display area. It's a revolutionary idea that facilitates the use of an oscilloscope like nothing else. And it's only from Philips. Once again.
- **16kV CRT.** Higher acceleration voltage and advanced electron optics assure brilliance and spot quality that outshines anything else in this class.
- **Pushbutton simplicity.** Quick, one-function buttons have replaced knobs for faster, surer, more reliable operation.

- **Instant-action AUTOSET.** Philips' intelligent beamfinder automatically selects channel, amplitude, timebase and triggering for error-free display of any input signal. Great for troubleshooting!
- **"Clever" cursors and delayed sweep.** Standard on the PM 3070, "clever" cursors supply immediate amplitude and timing measurements with direct CRT readout. And an exclusive cursor-operated ZOOM function offers the most efficient use of delayed sweep available in analog scopes.
- **Auto-Triggering intelligence.** Provides fast, stable triggering up to 150 MHz.
- **Probefactor compensation in LCD.** It automatically adjusts all readouts for the probe you're using.
- **IEEE compatibility.** For fast computer hook-up and automated production test and calibration.
- **Choice of four models:** Single and dual timebase; 60 or 100 MHz bandwidths.

SUPPORTING VIEW

Philips' medium-frequency instruments come with a 3-year warranty, a 30-day money-back guarantee and all the tech-

anical and service assistance you need. From Fluke—the people who believe that extraordinary technology deserves extraordinary support.

POINT OF VIEW

Call Fluke today at **800-44-FLUKE ext. 77**. And find out how easy it is to change the way you look at oscilloscopes.

Ask for your free copy of our new guidebook, Basic Principles of Oscilloscopes.

John Fluke Mfg. Co., Inc., P.O. Box C9090, M/S 250C, Everett, WA 98206
U.S.: 206-356-5400 CANADA: 416-890-7600
OTHER COUNTRIES: 206-356-5500

© Copyright 1988 John Fluke Mfg. Co., Inc.
All rights reserved. Ad No. 0481-P3065/70



SMART SERIES OSCILLOSCOPES • 60 & 100 MHz



Circle (8) on Reply Card

DELIVERY IS THE MOST IMPORTANT FUNCTION OF A PARTS DISTRIBUTOR. BUT IT'S NOT ENOUGH.

AVAILABILITY
DELIVERY
RELIABILITY
SUPPORT
NETWORKING
QUALITY

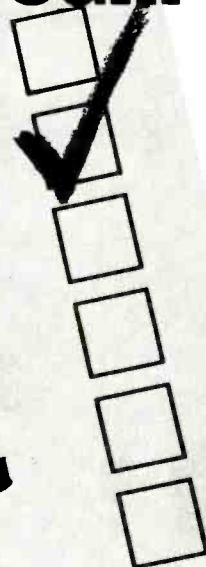

MATSUSHITA AUTHORIZED PARTS-LINK™ DISTRIBUTORS. BECAUSE IT PAYS TO BE SURE.

Some distributors are quick to promise fast delivery of replacement electronic parts. But they may not always be the right parts. That's never a problem when you put your trust in a Matsushita Authorized PARTS-LINK™ Distributor — your best source for Panasonic, Technics and Quasar original replacement parts. For basic stocking, each distributor maintains over 1,000 of the most demanded part numbers for off-the-shelf delivery. Even if the part you need isn't so common, your Matsushita distributor is tied into our exclusive PARTS-LINK™ network, tracking over 385,000 part numbers, so that we can locate the part you need, lock in the order, and deliver it — if overnight delivery is requested to your doorstep within 24 hours. They can even cross-reference these original

replacement parts to other Matsushita built products so that you can retain the high quality and reliability of Matsushita's design.

THE DIFFERENCE BETWEEN A PROMISE KEPT, AND A PROMISE BROKEN.

Your Matsushita Authorized PARTS-LINK™ Distributor isn't authorized by accident; each has met (and continues to meet) stringent requirements to ensure fast, courteous and responsive service backed by Matsushita's replacement parts warranty.

The right part at the right time from the right source. For the name and location of your Matsushita Authorized PARTS-LINK™ Distributor — see our listings at right. **YOUR SOURCE OF CONFIDENCE.**



MATSUSHITA SERVICES COMPANY

50 Meadowland Parkway, Secaucus, NJ 07094

Panasonic Technics Quasar

MATSUSHITA

AUTHORIZED REPLACEMENT PARTS DISTRIBUTORS

Panasonic® • Technics® • Quasar®

ARIZONA
 ARIZONA WHOLESALE SUPPLY CO. (C/M) • 2020 E. University Dr., Phoenix 85062 • 602-258-7901
 ELECTRONIC PARTS CO. (C/V/M) • 4021 N. 31st Ave., Phoenix 85017 • 602-227-7281

ARKANSAS
 AMERICAN ELECTRONICS (C/V/M) • 101 W. Rock St., Fayetteville 72701 • 501-442-8070

CALIFORNIA
 ANDREWS ELECTRONICS (C/V/M) • 905 Allen Ave., Glendale 91201 • 818-845-3536
 AUDIO VIDEO PARTS, INC. (C/M) • 1071 South La Brea Ave., Los Angeles 90019 • 213-933-8141
 CASS ELECTRONICS (C/V/M) • 801 Seventh Ave., Oakland 94606 • 415-839-2277
 CHUCK HURLEY ELECTRONICS (C/V/M) • 2557 Albattross Way, Sacramento 95815 • 916-927-5891
 E AND K PARTS, INC. (C/V/M) • 2115 Westwood Blvd., Los Angeles 90025 • 213-475-6848
 HURLEY ELECTRONICS (C/M) • 10712 Inglewood Ave., Inglewood 90304 • 213-678-7644
 HURLEY ELECTRONICS (C/M) • 730 W. Spruce, San Bernardino 92410 • 714-885-0721
 HURLEY ELECTRONICS (C/M) • 318 16th St., San Diego 92101 • 619-235-6245
 HURLEY ELECTRONICS (C/M) • 2101 N. Fairview, Santa Ana 92706 • 714-971-2992
 PACIFIC COAST PARTS (C/V/M) • 15024 Staff Court, Gardena 92048 • 213-515-0207
 WHOLESALE VACUUM (V) • 5811 Rose Ave., Long Beach 90813 • 213-428-6411

COLORADO
 DENVER-WALKER ELECTRONICS (C/V/M) • 299 Bryant St., Denver 80219 • 303-935-2405

CONNECTICUT
 SIGNAL ELECTRONICS SUPPLY, INC. (C) • 589 New Park Ave., West Hartford 06110 • 203-233-8551

FLORIDA
 HERMAN ELECTRONICS (C/V/M) • 1365 N.W. 23rd St., Miami 33142 • 305-634-6591
 LAYCO, INC. (C/V/M) • 501 South Main St., Crestview 32536 • 904-682-0321
 VANCE BALDWIN (C) • 2207 S. Andrews Ave., Fort Lauderdale 33316 • 305-523-3461
 VANCE BALDWIN (C/M) • 11629 N.W. 7th Ave., Miami 33168 • 305-769-0225
 VANCE BALDWIN (C/V/M) • 1007 N. Himes Ave., Tampa 33607 • 813-870-2606
 VANCE BALDWIN (C/V/M) • 500 Clematis St., West Palm Beach 33401 • 305-832-5671
 WALDER ELECTRONICS (C/V/M) • 1801 N.E. 2nd Ave., Miami 33132 • 305-379-4794

GEORGIA
 BUCKEYE VACUUM CLEANER (V) • 2870 Plant Atkinson Rd., Smyrna 30080 • 404-351-7300
 CLIMATIC CORPORATION (C/V/M) • 650 Old Norcross, Lawrenceville 30246 • 404-962-0737
 WHOLESALE INDUSTRIAL (C/M) • 5925 Peachtree Corners East, Norcross 30071 • 404-447-8436

HAWAII
 PANASONIC HAWAII, INC. (C/V/M) • 91-238 Kauhū St., Ewa Beach 96808-0774 • 808-682-2851

ILLINOIS
 B-B & W, INC. (C/V/M) • 2137 S. Euclid Ave., Berwyn 60402 • 312-242-1533
 HESCO, INC. (V) • 6633 North Milwaukee Ave., Niles 60648 • 312-647-6700
 HOWARD ELECTRONIC SALES (C/V/M) • 4573 Archer Ave., Chicago 60632 • 312-254-1777
 JOSEPH ELECTRONICS, INC. (C/M) • 8630 N. Milwaukee Ave., Niles 60648 • 312-297-4200
 UNION ELECTRONIC DIST. (C/V/M) • 16012 S. Cottage Grove, South Holland 60473 • 312-333-4100
 YEOMANS DISTRIBUTING CO. (C/V/M) • 1503 W. Altorfer Dr., Peoria 61614 • 309-691-0050

INDIANA
 ELECTRONIC SERVICE PARTS (C/V/M) • 2901 E. Washington St., Indianapolis 46201 • 317-269-1527

IOWA
 JONES DISTRIBUTING CO. (C/V/M) • 2650 Bridgeport Dr., Sioux City 51102 • 712-277-8600
 UNION SUPPLY COMPANY, INC. (C/V/M) • 231 S. 3rd St., Burlington 52601 • 319-754-5745
 YEOMANS DISTRIBUTING CO. (C/M) • 616 New York St., Des Moines 50313 • 515-280-8179

KANSAS
 G & A DISTRIBUTORS, INC. (C/V/M) • 635 N. Hydraulic St., Wichita 67201 • 316-262-3707

KENTUCKY
 MAJOR DISTRIBUTING COMPANY (C/M) • 449 S. 16th St., Paducah 42001 • 502-443-5345
 SERVICE ELECTRONICS SUPPLY (C) • 1046A New Circle Rd., NE, Lexington 40505 • 606-254-5786

MARYLAND
 FAIRWAY ELECTRONICS (C/V/M) • 3040 Waterview Drive, Baltimore 21230 • 301-576-8555
 FAIRWAY ELECTRONICS (C/V/M) • 4210 Howard Ave., Kensington 20795 • 301-564-1440
 TRITRONICS, INC. (C/V/M) • 1306 Continental Dr., Abingdon 21009-2334 • 301-676-7300

MASSACHUSETTS
 MIL ELECTRONICS (C/V/M) • 27-33 Jones Rd., Waltham 02154 • 617-891-6730
 SIGNAL ELECTRONICS SUPPLY, INC. (C) • 484 Worthington St., Springfield 01105 • 413-739-3893
 TEE VEE SUPPLY CO. (C/V/M) • 3211 Washington St., Boston 02130 • 617-522-9330

MICHIGAN
 POTTER DISTRIBUTORS (C/M) • 4037 Roger Chaffee Dr., S.E., Grand Rapids 49508 • 616-531-6860
 REMCOR ELECTRONICS (C/M) • 10670 Nine Mile Rd., Oak Park 48237 • 313-541-5624

MINNESOTA
 NESS ELECTRONICS, INC. (C/V/M) • 441 Stinson Blvd. NE, Minneapolis 55413 • 612-623-9505
 MID AMERICA VACUUM CLEANER SUPPLY CO. (V) • 666 University Ave., St. Paul 55104 • 612-222-0763

MISSISSIPPI
 TRI-STATE ELECTRONICS (C/V/M) • 605 W. Fortification St., Jackson 39203 • 601-355-3431

MISSOURI
 CITITRONIX, INC. (C/V/M) • 1641 Dielman Rd., St. Louis 63132 • 314-427-3420
 MANHATTAN ELECTRONICS, INC. (C/V/M) • 1101 E. 76th Terrace, Kansas City 64131 • 816-361-9440
 TACONY CORP. (V) • 1760 Glissinn Lane, Fenton 63036 • 314-349-3000

NEW HAMPSHIRE
 TEE-VEE SUPPLY CO. (C/V/M) • 58 Elm St., Nashua 03060 • 603-889-4171

NEW JERSEY
 NIDISCO ELECTRONICS (C/V/M) • 284-294 Passaic St., Passaic 07055 • 201-779-5520

NEW MEXICO
 ELECTRONIC PARTS CO. (C/V/M) • 2620 Rhode Island NE, Albuquerque 87110 • 505-293-6161

NEW YORK
 A & P ELECTRONICS (C/V/M) • 4144 Sunrise Highway, Massapequa 11758 • 516-541-4200
 DALE ELECTRONICS (C/V/M) • 7 E. 20th St., New York City 10003 • 212-475-1124
 GREEN TELE-RADIO DIST. (C) • 84-00 73rd Avenue, Glendale 11385 • 718-821-1114
 GMB SALES (C/M) • 2700 Middle Country Rd., Centereach 11720 • 516-585-8111
 MILL ELECTRONIC SUPPLY (C/V/M) • 2026 McDonald Ave., Brooklyn 11223 • 718-336-4575
 PAGO APPLIANCE PARTS (C/M) • 700 Broadway, Buffalo 14212 • 716-856-8133
 PANSON ELECTRONICS (C/V/M) • 268 Norman Avenue, Greenpoint 11222 • 718-383-3400
 RADIO EQUIPMENT CORP. (C) • 196 Vulcan St., Buffalo 14207 • 716-874-2690
 STAR FOR PARTS (V) • 250 Rabro Drive East, Hauppauge 11788-0255 • 800-525-6046 (Except CO)
 UNITED TELETRONIC PARTS (C/M) • 3860 10th Ave., New York 10034 • 212-LO9-2330

NORTH CAROLINA
 ALLISON-ERWIN CO. (C/V/M) • 2920 N. Tryon St., Charlotte 28232 • 704-334-8621

NORTH DAKOTA
 WESTECH DISTRIBUTING (C/V) • 1345 Main Ave., Fargo 58103 • 701-237-4885

OHIO
 FOX INTERNATIONAL, INC. (C/V/M) • 23600 Aurora Rd., Bedford Heights 44146 • 216-439-8500
 LARRICKS, INC. (C/V/M) • 23 Mackoll St., Dayton 45403 • 513-258-1211

OKLAHOMA
 AMERICAN ELECTRONICS (C/V/M) • 730 South Utica, Tulsa 74104 • 918-599-8866

OREGON
 DIVERSIFIED PARTS (C/V/M) • 2104 S.E. 9th Ave., Portland 97214 • 503-236-6140
 THE MOORE CO. (C/V/M) • 333 SE 2nd, Portland 97214 • 503-234-5000

PENNSYLVANIA
 AMERICAN VAC DISTRIBUTORS (V) • 3132 E. Thompson St., Philadelphia 19134 • 215-423-4522
 CRS ELECTRONICS (C/M) • 818 Brownsville Rd., Pittsburgh 15210 • 412-431-7700
 LINWOOD WHOLESALE, INC. (C/M) • 1139 Sumner Ave., Whitehall 18052 • 215-820-0357
 STEINBERG ELECTRONICS (C/V/M) • 2520 N. Broad St., Philadelphia 19132 • 215-BA3-9400

RHODE ISLAND
 JABBOUR ELECTRONICS (C/V/M) • 1744 Cranston St., Cranston 02920 • 401-944-2570

SOUTH CAROLINA
 WHOLESALE INDUSTRIAL (C/V/M) • 515 E. Bay St., Charleston 29403 • 803-722-2634

TENNESSEE
 CURRYS, INC. (C/V) • 923-8th Ave., S., Nashville 37203 • 615-242-4223
 MILLS MORRIS CO. (C/V/M) • 677 Phelan Ave., Memphis 38101 • 901-774-9810
 SHIELDS ELECTRONICS SUPPLY, INC. (C/V/M) • 4722 Middlebrook Pike, Knoxville 37921 • 615-588-2421

TEXAS
 ELECTRONIC COMPONENT (C/V/M) • 2401 Bissonnet, Houston 77005 • 713-528-1543
 FOX INTERNATIONAL (C/V/M) • 752 So. Sherman, Richardson 75081 • 214-231-1826
 M-TRONICS (C/V/M) • 3201 West Ave., San Antonio 78213 • 512-340-4069
 PORTER BURGESS CO. (C/V/M) • 1233 Levee St., Dallas 75207 • 214-741-5161
 VCP INTERNATIONAL, INC. (V) • 2285 Merritt Dr., Garland 75040 • 214-271-7474

VIRGINIA
 AVEC ELECTRONICS CORP. (M) • 711 Granby St., Norfolk 23510 • 804-627-3502
 AVEC ELECTRONICS CORP. (M) • 2002 Staples Mill Rd., Richmond 23230 • 804-359-6071
 FAIRWAY ELECTRONICS, INC. (C/V/M) • 2304 Chamberlayne Ave., Richmond 23222 • 804-321-7255

WASHINGTON
 P-E DISTRIBUTING (C/V/M) • P.O. Box 19315, Seattle 98109-1315 • 206-624-3112

WISCONSIN
 DYKRO, INC. (C/V/M) • N90 W14401 Commerce Dr., Menomonee Falls 53051 • 414-255-1900
 G.M. POPKEY COMPANY (C/V/M) • 2035 Larsen Rd., Green Bay 54307-2237 • 414-497-0400

CODING:
 (C) ... Consumer Electronic Parts
 (V) ... Vacuum Parts
 (M) ... Major Appliance Parts

* ... Full Line
 ** ... Panasonic Only
 *** ... Quasar Only
 **** ... Vacuum Only
 † ... For Dealers Only

(as of 6/17/88)

Parts Division

Matsushita Services Company, 50 Meadowland Parkway, Secaucus, NJ 07094

Circle (9) on Reply Card

The new breed of multimeters

By Conrad Persson

E = IR. That more or less sums up the idea of electricity and electronics. Of course, there's a lot more to it than that, but that relationship covers the first several chapters in most texts. It seems appropriate, then, that the most basic electrical/electronics tester, the multimeter, will test for E, I and R.

Of course, the multimeter is by no means the only piece of test equipment a technician needs to troubleshoot a de-

fective piece of consumer electronics equipment, as evidenced by the shelves full of test equipment used every day by competent technicians: oscilloscopes, frequency counters, signal generators and more. But used correctly, a multimeter, especially one of today's sophisticated units, can isolate many faults in electronic circuitry.

The basics

The most basic multimeter in today's arsenal of electrical/electronic test

eters is the volt-ohm-milliammeter (VOM). These units cost well under \$100, yet they let you check ac and dc voltages, resistances and currents in the milliamperage range. To some degree, you also can check for semiconductor junctions, and VOMs make dandy circuit continuity checkers, especially when they have audible output.

But you have to be sure to learn the capabilities and limitations of one of these basic instruments. For example, unless the meter is specified otherwise, its frequency response is probably limited. If you're trying to measure the value of a signal at several kilohertz, the signal will be attenuated by the input circuitry of the meter, and your measurement will not be accurate.

Another limitation of the typical low-cost multimeter is that most do not give a true rms indication of an ac waveform being measured, so if the signal you're measuring is not a pure sinusoid, the measured value will not be the true rms value. There are true rms meters, but they are generally considerably more expensive than other multimeters.

A bell here, a whistle there

Beyond the basic volt-ohm-milliammeter functions, one of today's sophisticated digital multimeters may contain a number of functions that have evolved over the years. The units with the most capabilities offer an array of measurement functions that technicians of a few years ago couldn't have even dreamed of.

Figure 1 is a generalized block diagram of a DMM. One of today's popular multimeter capabilities is a diode test. Not only does this function test diodes, but it also tests other semiconductor junctions, and so acts as a quick test of whether a diode or transistor junction is OK, open or leaky.

When a meter is used in the resistance-testing mode, it places a low volt-

Persson is editor of **ES&T**.



age with a constant-current characteristic across the test leads so that, once the leads are connected, the voltage across the test leads is determined by the product of the resistance being read and the known-constant current. The meter then measures that voltage and converts it into resistance.

The diode test is accomplished by placing a higher voltage across the meter's test leads than is available for most resistance ranges, but limiting the current to a smaller value than is allowed for the resistance measurements. This combination ensures that the semiconductor junction will be turned on when the meter is connected in the forward direction, but the current is limited to a safe amount that will not damage the junction.

Converting voltage into a digital signal

One of the more popular methods of converting a voltage into a digital signal is called the *dual-slope conversion method*, or the *double integration*

method. (See Figure 2 for an idea of how it works.)

V_{in} is the input voltage—the voltage to be measured. V_{REF} is a reference voltage of polarity opposite that of the measured voltage, supplied by the meter. Capacitor C and operational amplifier A constitute an integrator circuit. Switch S_1 is an electronic switch that is initially in the position shown.

When the meter probes are first connected to the voltage of interest, that voltage is applied to the input of the integrator for a period of time (called the *integration period*) that was determined by the designers of the meter. (Integration periods are ordinarily selected to be related to the 60Hz line frequency, so integration periods of 1/60th of a second and 1/10th of a second are common). The output of the integrator is a voltage that is determined by the RC time constant of R and C. Because of the nature of the integrator circuit, the maximum voltage (the voltage at the end of the integration period) is proportional to the voltage being measured.

At the end of the integration period, switch S_1 is moved to the other position and a voltage of polarity opposite to the polarity of the measured voltage is applied. In this configuration, the capacitor is discharged until its voltage reaches zero.

Take a look at Figure 2b. Note that the discharge interval will be directly proportional to the maximum voltage, which in turn is proportional to the applied voltage. As a specific case, if the input voltage is doubled, the discharge interval will double.

At the same time that the integration interval ends and the discharge interval begins, a counter that is part of the meter circuitry begins counting pulses generated by a clock circuit. When the voltage reaches zero, the counter stops counting. The number of pulses counted is, therefore, proportional to the discharge period, which, as we already pointed out, was proportional to the input voltage. This count is converted to

Main article continued on page 20.

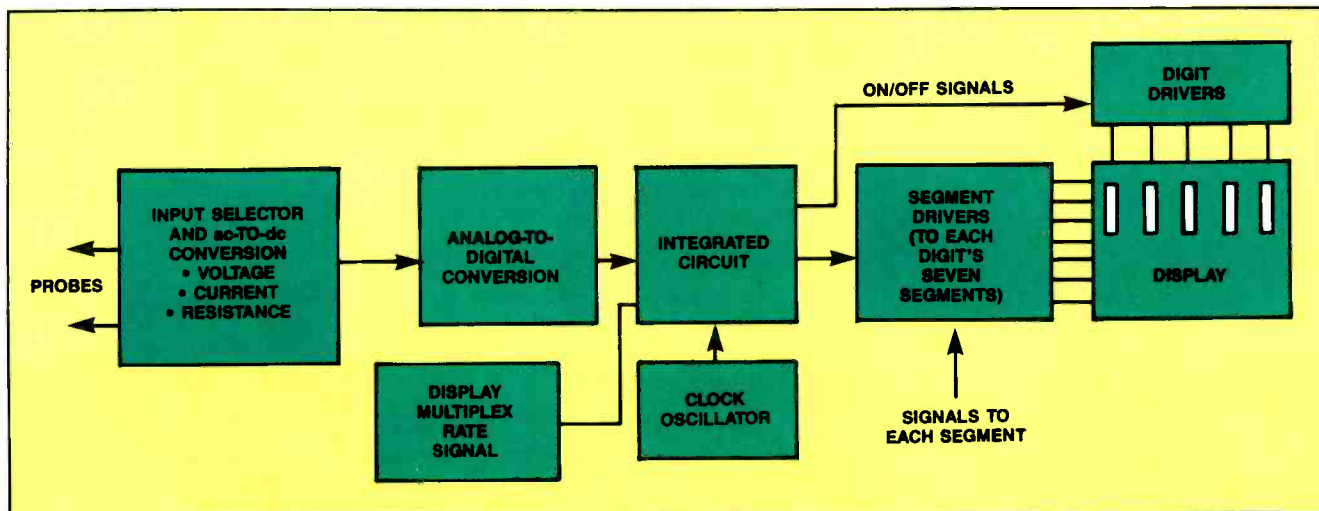

Figure 1. Because of the increasing sophistication in the fabrication of ICs, the construction of DMMs is evolving rapidly. However, this block diagram gives an idea of the general principles on which DMMs are based.

The new DMMs—heavy-duty and hands-free

By Rey Harju

Imagine this for trouble-free troubleshooting: You take out a heavy-duty DMM, hold it in one hand and flip the rotary selector switch to the function needed—say, volts. You don't worry about the range because the meter can set itself faster than you can. Using its built-in hanger, you hang the meter on the edge of a nearby equipment cabinet or wherever is handy. With both hands on the probes, you don't touch the DMM again throughout the entire service procedure. You don't even look at it again. Instead, it plays the reading audibly. With the new generation of smaller, heavy-duty DMMs that are just hitting the market, this scenario isn't the least bit fanciful.

Multimeters are general-purpose test instruments for measuring continuity,

ly into continuous, audible tones.

Keeping attention on the probes is also a safer way to work. However, even if test leads do accidentally make contact with dangerous voltages, the meter will sound a warning. Besides having extensive overload protection, these new meters sense dangerous voltages in the 200V and 1,000V ranges. When they're in auto-ranging mode, they will warn you with a loud beep and display a lightning-bolt symbol. As the meter enters either the 200V or the 1,000V range, it emits the warning.

Why heavy-duty?

Other than the fact that you can only get certain advanced features in the more expensive heavy-duty models, why else

The case provides this protection, but it generally adds bulk to the meter. Recent advances in VLSI circuit design have made it possible to shrink the size of the internal electronics. Those advances provided an opportunity to redesign the casing for a much more compact instrument, and the new heavy-duty DMMs are the result.

The new case is about the same size as two packs of cigarettes stacked on end, comparable to a typical telephone handset. Earlier ruggedized models are bigger and bulkier, about the size of a thick paperback book. The cases of heavy-duty DMMs are extremely strong and resilient; gaskets and O-rings seal the case against contaminants.

Your meters may need this protection even if they aren't used under particularly hazardous conditions. For example, a DMM could be knocked off a table or dropped as it is being slipped onto a belt. Dropping it from an antenna tower, telephone pole or scaffold is another common accident. There could come a time when you might get caught in the rain. Even indoors, a coffee spill at the bench could be costly—and aggravating—if a meter's in the way.

For rugged use, the meter (and its use) must be protected against electrical as well as mechanical hazards. Electronic protection devices inside the new DMMs meet or surpass those found in the best of the older, bulkier heavy-duty models. For example, fuses and resistors with positive temperature coefficients provide internal overload protection. The new, heavy-duty DMMs also incorporate metal-oxide varistors (MOVs), which are relatively expensive, solid-state devices that protect against high-voltage transients.

Hands-free, attention-free DMM operation

The compact size of the new DMMs means more than just being able to carry the meter conveniently into the field. Perhaps more important, compactness contributes to ease of use. With the new, slim designs, these meters can be held in one hand and operated with a flick of the thumb.

When the meter is in an auto-ranging mode, once the function is set, you can keep both hands and eyes on the work. This capability has become possible through fast auto-ranging combined with audible readout. The combination of fast, responsive auto-ranging with continuously variable tone generation has only recently become possible through an innovative approach to DMM circuit design.



Figure 1. Integrated circuit techniques allow meter manufacturers to pack a lot of circuitry into a small package, which allows designers to create a small, heavy-duty meter.

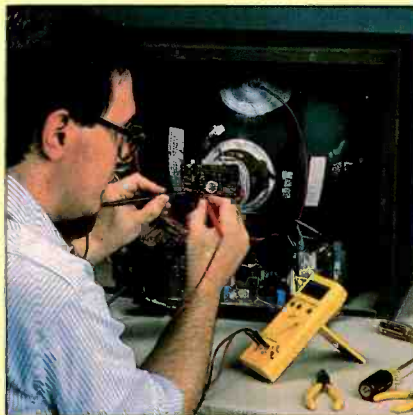

Figure 2. Some of the newer features such as autoranging and audible readout make it easier to concentrate on the work, not the tool.

voltage, resistance and current. Depending on the model, other functions can include capacitance, digital logic, transistor gain, frequency and temperature.

DMMs incorporate digital measurement circuitry and typically display numeric results as digits, or *counts*, on the face of an LCD. With some new DMMs, many types of service procedures only require you to listen as readings generate continuous, audible tones. This audible-readout feature has become possible as new A/D conversion technologies have been incorporated in advanced DMMs. Within these circuits, DMM inputs are converted to frequencies. These frequencies not only provide very fast auto-ranging but also are converted read-

might a technician consider a heavy-duty, or *ruggedized*, DMM? Although standard professional-grade multimeters may have much the same internal circuitry and overall accuracy, these instruments are subject to breakdown from any number of everyday occurrences, including getting zapped by electrical overloads, falling off a bench or accidentally getting wet. Major differences with heavy-duty DMMs are found in the casing and in electric protection devices. The major advantage of relying on a heavy-duty DMM ultimately is that you know it will work when you get to the job, regardless of the location or conditions.

Ruggedized casing

A DMM that is designed to withstand rugged use, particularly in industrial applications, must be both shock-resistant and tightly sealed against contamination.

Harju is the digital multimeter marketing manager for Beckman Industrial, Instrumentation Products division.



THE SIMPSON 560 MENU DRIVEN MULTIMETER. SOMETHING NEW ON THE MENU.

From microvolt transducer measurements to high voltage work, Simpson's new *Professional Series Model 560 Digital Multimeter* is designed to quickly give the answers you need—without elaborate signal conditioning.

Diagnostic functions such as MIN/MAX Hold and Peak Hold let you find and display transient amplitudes, while the bar graph continues to monitor the incoming signal. Programmable data logging on any range or function and a built-in 500 KHz frequency



counter, further expand the acquisition capabilities of the Simpson 560.

What's more, it's now possible to speed up routine tests—saving only the measurements of interest—because the 560 offers real-

time comparison to stored test limits. Permanent records of the captured data can be generated by computers or printers connected to the optional interfaces (Centronics, RS-232 or IEEE-488). Displayed menus make it quick and easy to set the measurement parameters. And ultra-fast autoranging inputs instantly calculate the proper scale.

Order from our menu. The Simpson 560 Menu Driven DMM. You'll agree that it's done quite tastefully.

Simpson Professional Series products are made in USA.

SIMPSON

Simpson Electric Company 853 Dundee Ave., Elgin, Illinois 60120-3090 312/697-2260 FAX: 312/697-2272

Circle (35) on Reply Card

www.americanradiohistory.com

The new DMMs—continued

From the viewpoint of a DMM user, the practical benefits are that the continuous, audible readout varies instantly and precisely to correspond to the signal.

Audible readout, of course, is the major breakthrough that completes the hands-free, attention-free concept. When you think about it, many types of service procedures do not require a numeric result. In peaking or nulling adjustments, for example, you only need to know whether the input is at maximum or minimum. When looking for intermittents, all you need to know is whether the signal is breaking up. Examples of service procedures that can be performed in this new, hands-free manner are given later in this article.

Working with digital circuitry

Transient digital pulses typically are too brief to be measured by analog detection circuits. In the past, a separate logic probe was needed for these measurements. When working with one of the new DMMs, however, all you do is

switch to logic-detection mode, using standard probes. If a data signal is present, the meter emits an audible beep, thus eliminating the hassle of having to change instruments right in the middle of a job.

Automatic shutoff

Also new to the test-instrument marketplace is true automatic shutoff, which eases the annoyance of changing batteries. On some DMMs with this feature, the device switches to a low-drain condition. The new DMMs, however, will turn themselves off completely after an hour of unattended operation.

If your DMMs are used in the field, you know that it is annoying to have to change batteries frequently. This is a common complaint about low-cost DMMs, for which typical battery life can be as short as 75 hours. Longer battery-change intervals provide less of a chance for your technicians to get stuck somewhere with a dead meter and no spare battery. Changing the batteries less

often also reduces the number of times your meters might be exposed to contamination while the case is open.

Cost/benefit evaluation

Because the new DMMs cost a little more, a cost/benefit evaluation might be helpful. To many servicing technicians, the new DMMs will represent a better value over lower-cost meters. Besides incorporating features such as auto-ranging and audible readout, which promote hands-free operation, the new heavy-duty DMMs offer the added value of ruggedness and dependability.

The advances in DMM technology pay dividends in the area of dependability: The new DMMs are engineered to include a minimum of moving parts. Auto-ranging eliminates much of the need for mechanical switch movement and reduces the number of electrical contacts in the meter. This can *design out* some of the potential sources of failure, such as corrosion and resistance of the contacts, which can contribute to poor per-

GOLD VALUE

Gold-plated PC boards are used on every ARI's DMM for the ultimate in reliability

Battery Eliminator Jack for Extended Bench Operation

Intelligent Auto Power Off Circuit Extends Battery Life (Patent Pending)

High quality Components Used Throughout

Heavy Duty 20A Current Shunt



LCD Function Annunciators Eliminate Need to "Interpret" Reading.

Gold-Plated PC Board for Superior Reliability

Advanced SMT Design for Higher Reliability

Thick-Wall Banana Jacks for Long Connector Life



AR-130

- Unique, Intelligent APF* (Patent Pending)
- Complete Function & Range Annunciation
- Heavy Duty 20A Current Shunt
- Auto Power off Function



AR-170NL

- Level Measurement in dBm
- True RMS AC Measurements
- 20mV, 20mA and 20Ω Ranges
- 3KHz-Flat Weighting Filter for Noise Measurement
- 0.1% Basic Accuracy



AR-180T

- 0 & -13dBm Four Frequency Tone Generator
- "C-Message" Noise Weighting Filter
- System Noise and Level Measurement in dBm
- Also Measures DCV and Ω's with Continuity
- Loop Current Tests



ARI/AMERICAN RELIANCE INC.

9241E, VALLEY BLVD., ROSEMead, CA 91770

TE.: (800)554-9838 (818)287-8400 FAX: (818)287-8855

ARI manufactures a complete line of electronic test equipment, including EPROM, EEPROM, and PLD programmers, IC testers, Cable testers, DPMs, DMMs, and Logic testing devices. Call or write today for your free Brochure.

Circle (10) on Reply Card

IT'S A
\$41 BILLION
INDUSTRY
AND THERE'S A SHARE
TO SPARE...
IF
YOU'RE
THERE.

Zero-In On Your 1989 Market At Winter CES.

The Consumer Electronics Show is the only way you can keep up with everything that's happening—non-stop—in consumer electronics.

The Products. Audio, video, furniture, photographic equipment and accessories; mobile electronics, car audio, cellular and security; telephones, TADs and accessories; home office; educational/recreational hardware and software; prerecorded video software; watches and personal electronics; specialty audio. That's a lot to keep up with. But there's more.

Sources. Marketing and merchandising. Price-points and margins. Competition.

News. Stories. Trends. Promotions that worked, or fizzled. Personal experiences. And still more.

The People. Nearly 25,000 representing 1,350 exhibiting companies. Often they're the real reason why you buy from one company and not another. Even when products and pricing are identical. CEOs and Presidents; Sales, Marketing, Credit, and Advertising Managers. And the company images they project.

The Winter CES.® It tells you how to be a prophet, and how to turn one, at the same time.

Register Now! Save the \$25 On-Site Fee. Get exclusive discounted airfares—call American Airlines, 1/800-433-1790 or CW Travel, 1/800-524-4433 and identify yourself as a Winter CES traveler.

For Exhibitor Information please call or write: Consumer Electronics Shows Exhibit Sales, Temporary Headquarters, 1722 Eye Street, NW, Suite 200 Washington, DC 20006 USA

1989 International Winter Consumer Electronics Show.® Saturday, January 7 through Tuesday, January 10 Las Vegas, Nevada USA

For the trade only. No one under 18 years of age will be admitted. Over-the-counter sales are not permitted.

Pre-register Now. Take advantage of the advance complimentary registration and save the \$25 on-site fee.

Mail this completed form to Consumer Electronics Shows, c/o CompuSystems, Inc., P.O. Box 6579, Broadview, IL 60153-6579.

To obtain your badge by mail, we must receive this form no later than Thursday, December 15. **Attach your business card for proper verification and prompt processing.** If we receive this form after December 15 and before December 28, 1988, you may pick up your badge at the "Advance Registration Pick-up Desk," after showing two forms of ID, in the main registration area of the Las Vegas Convention Center, West Hall, the Hilton Hotel, Sahara and Riviera Hotels. Registration Forms received after December 28 will not be processed. Please register on-site after paying \$25.00.

To register more than one qualified individual, please duplicate this Advance Registration Form and attach business cards. Complete Show information, including housing form, will be sent separately.

**1989 International Winter Consumer Electronics Show[®]
Saturday, January 7 through Tuesday, January 10, 1989
Las Vegas, Nevada USA**

Name
Company
Street
City State Zip
Phone
*Only 21 characters including spaces will appear on your badge. Last four digits of your Social Security # (for internal use only)

Please check **only one** badge category:

- 1 Retailer
- 2 Distributor
- 3 Dept./Chain Store Buyer
- 4 Prem./Catalog Buyer
- 5 Manufacturer's Rep
- 6 Manufacturer
- 7 Institutional Buyer
- 11 Adv./Mktg./PR/Consultant
- 12 Financial/Market Analyst



The Consumer Electronics Shows are sponsored and produced by the Electronic Industries Association Consumer Electronics Group.

The new DMMs—continued

formance and ultimately to failure of the meter itself. Gold plating other contacts can further reduce the chance of failure.

With non-ruggedized DMMs, the possibility of malfunction is a hidden cost that should be taken into account. At today's repair costs, it can be less expensive to scrap a defective low-cost DMM and merely replace it. After you've done this a few times, you might well have exceeded the cost of the higher-priced, heavy-duty DMM. Of course, if your meter fails in the field, the cost in customer downtime or lost goodwill might greatly exceed the instrument repair costs.

Servicing applications

Applications for audible-readout DMMs extend to most types of diagnostic and repair work in which the objective is to sense maximum or minimum signal. Examples would include adjusting an amplifier for peak output or a damper for low noise. For such peaking and nulling tests, you can keep your hands (and eyes)

on the test leads and potentiometer while you listen for the highest or lowest tone the meter will produce.

It's common to suspect an intermittent connection, especially in diagnostic work. Problems may come down to a broken trace on a PCB, a defective connector or IC pin or a cracked solder pad. Just identifying the problem can be difficult—you've got to be able to induce the failure. It's important to be able to know exactly what you are doing at the precise moment the failure occurred.

One of the most straightforward ways to induce failure is to try the *wiggle test*. Connect a DMM to either side of the circuit and test for changes in output as you stress selected components. On a conventional analog meter, the intermittent connection shows up as a fluctuation of the needle. On a DMM, the digital readout will shift numerically up and down in an apparently random fashion. The difficulty in either case, of course, is that you have to look at the meter to see this change.

With either of these techniques, you could easily miss something as you shift your attention between the meter, the test leads and the device. With audible readout, you connect the DMM, wiggle the board or connector and simply listen. If there's an intermittent connection there, you'll hear a characteristic crackling noise as the tone breaks up. You can measure voltage, current or resistance, and you don't have to be directly across the potentially offending component. The leads only have to be somewhere between the test points, because all you are listening for is a discontinuity in the frequency of the tone. Because you don't have to look at the meter at all, you'll have a better chance of seeing exactly what you were doing when the elusive bad connection revealed itself. Again, you can do this in volts, amps or ohms, whichever is most convenient.

In short, greater convenience, ease of handling and advanced features allow many of the new DMMs to dramatically improve troubleshooting.

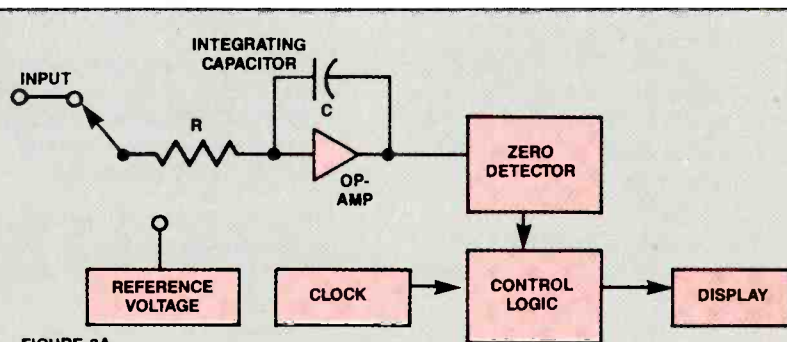

FIGURE 2A

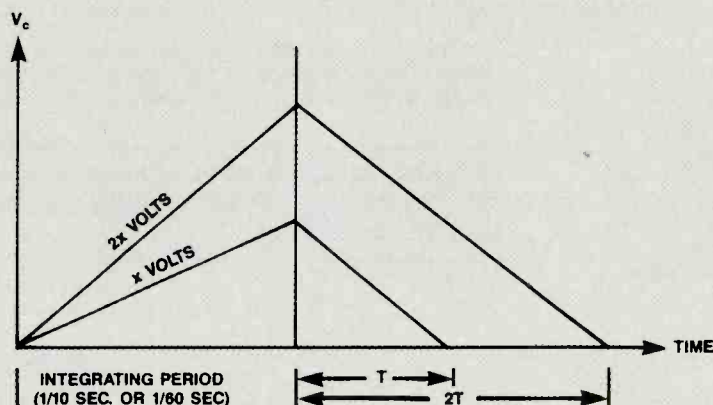

FIGURE 2B

Figure 2. The block diagram in Figure 2a gives a basic idea of how analog-to-digital conversion is accomplished using the dual-slope technique. Figure 2b shows a graph of V_c vs. time. Because the slope of the discharge curve is identical regardless of the ultimate voltage reached by the integrator, the discharge period and, therefore, the number of counts recorded by the logic circuitry is proportional to that voltage.

Main article continued from page 15.

a digital number and displayed as the measured voltage. Although this method works well, it is somewhat slow, so many microcomputer-based meters use a variation called *multislope integration*, which we won't go into here.

Multimeters offer more possibilities today than they ever have before. Large-scale integration (LSI) is making it possible to pack more and more functions into the relatively limited space inside a DMM, and to do so without significantly increasing the cost of the device. In addition, because of competition among manufacturers, the functionality of DMMs is improving. The result: increasingly sophisticated products.

ES&T

Master Handbook of 1,001 Practical Electronic Circuits—Solid-state Edition, edited by Kendall Webster Sessions; 420 pages; \$19.60 paperback \$28.95 hardbound.

This reference to solid-state circuits allows professionals and hobbyists to build fire alarms, moisture detectors, 4-channel stereo decoders, repeaters, audio filters, burglar alarms and other devices for the home, shop or car.

TAB Professional and Reference Books, Blue Ridge Summit, PA 17294-0850; 717-794-2191.

Electronic Servicing Data and Procedures, by Robert C. Genn, Jr.; Prentice-Hall; 373 pages; \$16.95, paperback.

This workbench manual provides almost 200 step-by-step servicing tests and measurements for servicing electronics equipment. The handbook includes servicing tests for analog and digital equipment, including solid-state circuit tests and measurements and coverage of microprocessing units, optoisolators and phototransistors. The guide also contains figures and tables that reflect actual circuits, plus examples, diagrams and checklists that simplify diagnosis and speed servicing.

Prentice-Hall, Business and Professional Division, Englewood Cliffs, NJ 07632.

Complete Guide to VHS Camcorder Troubleshooting and Repair, by John D. Lenk; Prentice Hall; 317 pages; \$38, hardbound.

This guide presents a simplified, practical system of repairing VHS camcorders for technicians familiar with the basics of television, magnetic recording and VHS VCRs. The guide concentrates on how the circuits work to help readers reason out a logical troubleshooting approach. A troubleshooting chapter includes service notes for a cross-section of camcorders, describing the most common trouble symptoms reported to manufacturers' service personnel.

Prentice-Hall, Englewood Cliffs, NJ 07632; 800-223-1360.

Cable Television Technology, by Kenneth T. Deschler; McGraw-Hill; 262 pages; \$18.95, paperback.

Written with the technical assistance and endorsement of the Electronic Industries Association (EIA), this book

prepares students to work as technicians in the cable TV (CATV) industry. Topics covered include traditional "line-man"-oriented topics—an overview of CATV history, franchising, job classifications and operational units, and a review of TV broadcast electronics and equipment—as well as high-technology subjects associated with satellite anten-

nas and fiber-optic links. Each chapter includes learning objectives, a summary and review questions and, where appropriate, numerical problems. Appendices cover map symbols, troubleshooting and test procedures.

McGraw-Hill Book Company, 1221 Avenue of the Americas, New York, NY 10020; 212-512-4085.

Continued on page 25.



All the technical data of 83 Hitachi TV Manuals—in just two volumes



Our new Hitachi TV Schematic Manuals give you the best of both worlds—

With the compact storage of 32X microfiche and full-view hard copies of the items you use the most. Organized by year and model number in both formats, these volumes give you everything you need—83 models from 1975–1981. They're neatly packaged, easy to use, and economically priced.

You'll get hard copies of:

- Schematic Diagrams • Block Diagrams
- Printed-Circuits Board Layouts • Part Lists • Mechanical Part Exploded Views

And get the works on microfiche:

- Service Manuals with Technical Data and Information • Troubleshooting Tips • Revised or Supplemental Manuals • Instruction

Manuals • Parts and Service Bulletins

Volume I covers: 54 models from 1975–1978.

Volume II covers: 29 models from 1979–1981.

That's a lot of service data for a low **\$54.95** per volume! About what you would expect to pay for information on only two models. Or save even more by getting both volumes for just **\$104.00**. Take advantage of these savings now. It's a simple, cost-effective way to increase proficiency and increase profit. Also available are our VCR Volumes I, II and III.

Call toll-free 1-800-447-2882 for your nearest Authorized Hitachi Distributor

HSC Service Company

division of Hitachi Sales Corporation of America

Circle (11) on Reply Card

MINNESOTA
Ness Electronics
Minneapolis, MN 55413
612-623-9505

*F C Hayer
Plymouth, MN 55441
612-546-3777

Pace Electronics
Rochester, MN 55901
507-288-1853

MISSISSIPPI
Bluff City Elec.
Columbus, MS 39701
601-328-6212

Tri State Elec.
Greenville, MS 38701
601-335-3594

E A Helwick Elec.
Gulfport, MS 39501
601-863-1295

Gilliland Elec. Supply
Hattiesburg, MS 39401
601-584-8404

Tri State Elec.
Jackson, MS 39203
601-355-3431

Hooper Elec. Supp
Meridian, MS 39301
601-693-2668

Pate Elec. Supply
Tupelo, MS 38801
601-842-2576

MISSOURI
Show-Me Electronics
Cape Girardeau, MO 63701
314-334-0244

Show-Me Electronics
Flat River, MO 63601
314-431-4816

Show-Me Electronics
Jefferson City, MO 65109
314-636-2191

Manhattan Electronics
Kansas City, MO 64131
816-361-9440

Show-Me Electronics
Ladonia, MO 65401
314-364-3896

Show-Me Electronics
Sedalia, MO 65301
417-862-4171

Show-Me Electronics
Springfield, MO 65802
417-869-0752

Deltronics Dist.
St. Charles, MO 63301
314-946-6766

Show-Me Electronics
St. Joseph, MO 64501
816-233-3118

*Cititronix
St. Louis, MO 63132
314-427-3420

Deltronics Dist.
St. Louis, MO 63112
314-725-6060

MONTANA
*Interstate Dist.
Billings, MT 59102
406-245-5141

NEBRASKA
*Scott Elec. Supply
Lincoln, NE 68504
402-466-8221

*Scott Elec. Supply
Omaha, NE 68117
402-734-6750

D & H Elec. Supply
Scotts Bluff, NE 69361
308-632-2181

NEVADA
Hurley Elec. of Las Vegas
Las Vegas, NV 89104
702-384-5666

NEW HAMPSHIRE
*Tee-Vee Supply
Nashua, NH 03060
603-889-4171

NEW JERSEY
Mid State Radio Supply
Berlin, NJ 08009
609-767-1605

Rein Distributors
Burlington, NJ 08016
609-337-4800

G R S Electronics
Camden, NJ 08102
609-964-8560

*Leader Elect Supply
Hillside, NJ 07205
201-354-4200

NIDISCO
Lodi, NJ 07644
201-773-1771

*NIDISCO
Passaic, NJ 07055
201-779-5520

Carl B Williams
Phillipsburg, NJ 08865
201-454-8585

Linwood Wholesale
Wall Township, NJ 07727
201-938-6160

NEW MEXICO
Walker Elec. Supply
Albuquerque, NM 87107
505-883-2992

NEW YORK
Standard Electronics
Amherst, NY 14150
716-691-3061

Jayso Electronics
Bronx, NY 10467
212-798-1050

NE Radio Warehouse
Bronx, NY 10468
212-295-7034

Mill Elec. Supply
Brooklyn, NY 11223
718-336-4575

Universal Components
Brooklyn, NY 11214
718-259-4990

G T E Elec. Supply
Centereach, NY 11720
516-585-8111

Eiger Electronics
Farmingdale, NY 11735
516-249-4340

Mannfred Electronics
Flushing, NY 11355
718-762-7777

Green Tele Radio Dist.
Glendale, NY 11385
718-821-1114

Panson Electronics
Greenvale, NY 11222
718-383-1550

Electronic Parts Supp.
Latham, NY 12110
518-783-5204

*Green Tele Radio Dist.
Long Island, NY 11570
516-766-1353

A & P Electronics
Massapequa, NY 11758
516-541-4200

Standard Electronics
Olean, NY 14760
607-754-3102

Greylock Electronics
Poughkeepsie, NY 12601
914-452-0550

Standard Electronics
Rochester, NY 14606
716-254-7950

Rome Electronics
Rome, NY 13440
315-337-5400

Grimmers Elec. Supply
Schenectady, NY 12307
518-374-8480

Standard Parts
Syosset, NY 11791
516-881-7270

Salina Electronics
Syracuse, NY 13210
315-422-2336

Standard Electronics
Syracuse, NY 13204
315-422-0471

NORTH CAROLINA
SE Elec of Asheville
Asheville, NC 28806
704-253-1446

SE Elec of Charlotte
Charlotte, NC 28210
704-523-1122

*Southern Radio
Charlotte, NC 28224
704-588-5590

SE Elec of Durham
Durham, NC 27701
919-688-8204

Brantley Elec. Supply
Fayetteville, NC 28303
919-868-8038

SE Elec of Fayetteville
Fayetteville, NC 28301
919-483-0371

SE Elec of Greensboro
Greensboro, NC 27405
919-273-8675

Pair Electronics
Greensville, NC 27834
919-756-2291

SE Elec of Hickory
Hickory, NC 28601
704-322-9493

SE Elec of Jacksonville
Jacksonville, NC 28540
919-347-5173

SE Elec of Kinston
Kinston, NC 28501
919-523-5113

SE Elec. of Raleigh
Raleigh, NC 27603
919-828-2311

SE Elec of Wilmington
Wilmington, NC 28403
919-791-7365

NORTH OAKOTA
S/S Electronics
 Fargo, ND 58108
701-237-5003

OHIO
Sun Radio
Akron, OH 44308
216-434-4301

Fox International
Bedford Hts., OH 44146
216-991-7777

*CDC Appliances
Cincinnati, OH 45227
513-241-8670

Srepro Wintronic
Dayton, OH 45439
513-293-0871

Superior Elec. Parts
Parma, OH 44129
216-842-7940

*Hamburg Brothers
Solon, OH 44139
216-248-1670

Glen Elec. Supply
Youngstown, OH 44507
216-743-1119

OKLAHOMA
Sooner Radio & TV
Muskogee, OK 74403
918-682-1384

*Dulaney
Oklahoma City, OK 73118
405-528-0511

Radio Supply
Oklahoma City, OK 73102
405-232-6127

Sooner Electronics
Tulsa, OK 74104
918-599-8866

OREGON
*North Pacific Supply
Clackamas, OR 97015
503-656-2940

Double O Elec. Dist.
Portland, OR 97210
503-248-9500

J W Electronics
Salem, OR 97301
503-399-0085

PENNSYLVANIA
Allegheny Electronics
Alltoona, PA 16601
814-946-0871

Cumberland Electronics
Harrisburg, PA 17104
717-233-5883

Moyer Elec. Supply
Hazleton, PA 18201
717-455-3631

Allegheny Electronics
Johnstown, PA 15902
814-536-3589

Linwood Wholesale
Marcus Hook, PA 19061
215-485-0777

H B F Electronics
Philadelphia, PA 19149
215-338-1100

Jem Electronic Dist
Philadelphia, PA 19124
215-743-3030

Steinberg Electronics
Philadelphia, PA 19132
215-223-9400

CRS Electronics
Pittsburgh, PA 15210
412-431-7700

*Hamburg Brothers
Pittsburgh, PA 15222
412-227-6233

Moyer Elec. Supply
Pottsville, PA 17901
717-622-7866

G R S Electronics
Reading, PA 19605
215-375-4477

Key Radio TV & Satellite
Scranton, PA 18509
717-342-0161

Moyer Elec. Supply
Sunbury, PA 17801
717-286-6700

Linwood Wholesale
Whitehall, PA 18052
215-820-0357

RHODE ISLAND
Jabbour Elec. Supplies
Cranston, RI 02920
401-944-2570

Jabbour Elec. Supplies
Pawtucket, RI 02860
401-728-4600

SOUTH CAROLINA
Wholesale Indust. Elec.
Charleston, SC 29403
803-722-2634

Wholesale Indust. Elec.
Columbia, SC 29201
803-256-0746

*Southern Radio Parts
Fort Mill, SC 29715
704-588-5590

Wholesale Indust. Elec.
Greenville, SC 29609
803-235-8334

Wholesale Indust. Elec.
North Charleston, SC 29405
803-747-9672

Cantrell Wholesale Prod.
Taylors, SC 29687
803-268-1194

SOUTH DAKOTA
Chris Supply
Rapid City, SD 57701
605-342-5900

*Warren Supply
Sioux Falls, SD 57104
605-336-1830

TENNESSEE
Shields Elec. Supply
Bristol, TN 37620
615-764-0157

*Radco
Chattanooga, TN 37404
615-756-6032

Shields Elec. Supply
Chattanooga, TN 37407
615-624-0071

Randolph Hale & Matthews
Clarksville, TN 37040
615-647-2325

Randolph & Williams
Columbia, TN 38401
615-388-7566

Townsend Elec. Supply
Jackson, TN 38301
901-422-6585

Shields Elec. Supply
Knoxville, TN 37921
615-588-2421

Bluff City Elec.
Memphis, TN 38116
901-345-9500

*McDonald Brothers
Memphis, TN 38106
901-948-2771

Bluff City Elec.
Nashville, TN 37210
615-242-8000

Randolph & Rice
Nashville, TN 37203
615-255-5602

Garrett Electronics
Parsons, TN 38363
901-847-2468

TEXAS
F & M Electronics
Ablene, TX 79604
915-672-2839

Electrotex
Austin, TX 78757
512-476-7644

Electrotex
Beaumont, TX 77707
409-838-6421

Electrotex
Corpus Christi, TX 78412
512-993-9697

Electrotex
Dallas, TX 75243
214-234-0433

*Interstate Electric
Dallas, TX 75234
214-233-5757

Ft. Worth Wintronic
Ft. Worth, TX 76105
817-534-7696

Electronic Components
Houston, TX 77005
713-528-1543

Electrotex
Houston, TX 77098
713-526-3456

Electrotex—North
Houston, TX 77022
713-695-6851

Electrotex—East
Houston, TX 77017
713-941-7016

Houston Wholesale Elec.
Houston, TX 77087
713-644-8320

*McDonald Sales
Houston, TX 77041
713-894-4400

Apollo Wholesale Elec.
Irving, TX 75060
214-399-8195

Guarantee Radio Supply
Laredo, TX 78040
512-722-3233

Jett Racing & Sales
Laredo, TX 78040
512-722-3102

UETA
Laredo, TX 78041
512-722-7601

*Nunn Electric Supply
Lubbock, TX 79403
806-745-3611

Electrotex
Lufkin, TX 75901
409-632-4409

Commercial Elec.
Midland, TX 79701
915-682-9647

Fox International
Richardson, TX 75081
214-231-1826

*Electrotex
San Antonio, TX 78201
512-735-9271

Sherman Elec. Supply
San Antonio, TX 78212
512-224-1001

Wiltronics Supply
Tyler, TX 75702
214-597-6315

Elec. Components Distsr.
Victoria, TX 77901
512-575-4738

The Hargis Company
Waco, TX 76701
817-754-5667

Nunn Electric Supply
Wichita Falls, TX 76301
817-766-4203

UTAH
*Ballard Supply
Salt Lake City, UT 84119
801-972-2430

VIRGINIA
Harco Electronics
Alexandria, VA 22314
703-548-5115

Cain Electronics
Norfolk, VA 23502
804-855-3394

*Fairway Electronics
Richmond, VA 23222
804-321-7255

Goldberg
Richmond, VA 23222
804-771-5762

Southeastern Elec.
Roanoke, VA 24012
703-344-6611

WASHINGTON
J W Electronics
Everett, WA 98201
206-258-4339

*D & H Dist.
Seattle, WA 98188
206-575-0604

J W Electronics
Spokane, WA 99202
509-535-5800

*Prudential Dist.
Spokane, WA 99202
509-535-9777

J W Electronics
Tumwater, WA 98502
206-943-1071

J W Electronics
Yakima, WA 98903
509-575-1234

WEST VIRGINIA
Electronic Supply
Huntington, WV 25701
304-523-6443

WISCONSIN
*Taylor Electric
Mequon, WI 53092
414-241-4321

G M Popkey
New Berlin, WI 53151
414-786-5887

WYOMING
Houge Radio & Supply
Cheyenne, WY 82001
307-632-6474

List subject to change at any time.

Circle (12) on Reply Card

www.americanradiohistory.com

Computer-aided design tool for microchips

Scientists at the GE Research and Development Center have developed an advanced *silicon compiler* geared to the design of algorithm-specific chips for high-technology applications requiring high-speed digital signal processing.

With this second-generation chip-design software, known as PARSIFAL, it is possible to create algorithm-specific integrated circuits (ASICs) that perform their functions in a fraction of the time required by comparable devices designed by existing compilers. Speeds of 500 million operations per second are possible with chips compiled with the new software.

The speed is in the architecture

The faster number-crunching speed of ICs compiled with PARSIFAL is a result of the new compiler's ability to create chip designs having *digit-serial* architectures. This architecture enables the chips to add, multiply and perform other arithmetic operations on "words" composed of digits up to 16 bits wide. This approach replaces the method employed in first-generation, pipelined digital signal-processing (DSP) compilers, which are limited to the design of chips with *bit-serial* architectures (those that can deal with only 1-bit-wide digits).

The differences between the two chip architectures can be visualized by thinking of them in terms of factory assembly

lines. In the bit-serial configuration, one "part" (bit of information) comes down the assembly line at a time and is subjected to a series of "machining" (arithmetic operations), one after another, as it travels along.

In the digit-serial architecture, on the other hand, there could be as many as 16 "parts" (16-bit-wide digits) going down the assembly line in tandem. Sixteen "tools" would be at each of the "work stations," and 16 finished parts would arrive at the end of the assembly line in the same time as it took the bit-serial "assembly line" to make one.

Choosing digit sizes for flexibility

In addition to the design of higher throughput chips, the new compiler boasts a flexibility that did not exist before. With PARSIFAL, a chip designer can evaluate tradeoffs between operating speed and chip area/cost by experimenting with different digit sizes.

For maximum speed, the designer would select the biggest digit size possible. However, this would require the largest—and, thus, most costly—chip. Choosing an intermediate value of digit size usually yields the most efficient chips in terms of information throughput per given area.

Several chips have been successfully compiled employing PARSIFAL. Among them is a 60,000-transistor arctangent chip designed to change Carte-

sian coordinates to their polar forms. This chip, developed for a medical application, computes 10 million operations per second at a sample update rate of 10MHz.

Once the algorithms or mathematical equations describing the arctangent chip's functional requirements had been finalized, it took a designer one day to generate an initial layout using PARSIFAL. It is estimated that this process could have taken up to five person-years employing conventional design methods. The complete design/optimization cycle involved ten iterations of the chip and took two weeks.

How it works

With the compiler (which is implemented on a Sun work station), the designer begins by entering the algorithms describing the chip's function, employing a programming language similar to C. In the case of the arctangent chip, this step required about 150 lines of code. The compiler then simulates the algorithms to confirm that they do what the designer wants.

Next, the compiler draws on its family of basic ASIC building blocks (called *leaf functions*), each of which is designed to do a single function such as addition or multiplication. It automatically picks out the leaf functions needed, lays them out following design rules, and "draws in" conducting wires that hook the building blocks together. The compiler has built-in optimization routines that serve to maximize layout density and minimize the length of the interconnect wires.

The compiler then simulates the operation of the circuit design, again to make sure it does what the algorithm asks. If it does, the compiler is then turned loose to convert the computerized chip representation (the array of interconnected building blocks) into a layout of transistors and other actual circuit elements. The file that results from this process is then fed into a system that creates the mask set needed for fabricating the chip.

ES&T

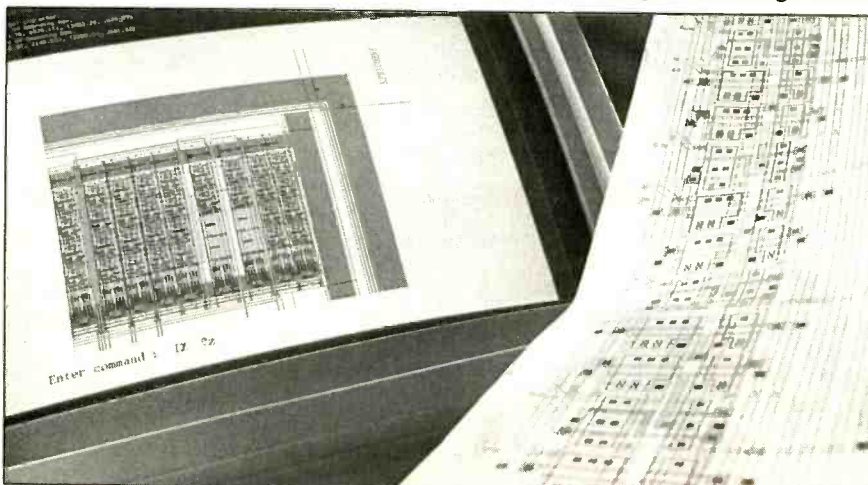

Continued from page 21.

Bob Middleton's Handbook of Electronic Time-savers and Shortcuts, by Robert G. Middleton; Prentice-Hall; 378 pages; \$16.95, paperback.

The little-known tricks of the trade, quick tests, tips and shortcuts explained in this handbook help in troubleshooting radio, TV, audio, CB, tape-recorder, intercom, CCTV, telephone and digitally controlled equipment. Instructions and illustrations show new servicing techniques, methods for getting the most from testers and new ways to use conventional test instruments. The book, written for beginning to advanced troubleshooters and hobbyists, contains complete plans for building test instruments, plus BASIC computer programs that simplify circuit analysis.

Prentice-Hall, Business and Professional Division, Englewood Cliffs, NJ 07632.

Digital IC Digest; D.A.T.A.; 850 pages; \$110. (Quarterly updates: \$60.)

The new *Digital IC Digest* reference source from D.A.T.A. lists and cross-references major electrical characteristics for more than 46,000 devices available from approximately 175 manufacturers of digital ICs. The reference shows device pinouts, critical specifications and packaging information. Other sections list discontinued devices and replacement device information.

D.A.T.A. Business Publishing, 9889 Willow Creek Road, P.O. Box 26875, San Diego, CA 92126; 800-854-7030, ext. 570 (in California, 800-421-0159, ext. 570).

Alarms: 55 Electronic Projects and Circuits, by Charles D. Rakes; 160 pages; \$12.60 paperback, \$19.95 hardbound.

The projects in this book are designed to show the variety of alarms that are available and to provide readers with step-by-step instructions for actually building their own alarms. The book shows how to build light alarm sensors, ultrasonic sensors, normally closed and normally open alarm systems, temperature sensors, multi-input alarm systems and more. The author also describes how to install systems in homes and cars.

TAB Professional and Reference Books, Blue Ridge Summit, PA 17294-0850; 717-794-2191.

Interface ICs Digest, Edition 24; D.A.T.A. Business Publishing; 780 pages; \$110 (with quarterly updates, \$170).

This reference, which provides data on 21,840 devices from 165 manufacturers, presents device pinout information; identifies devices by function, generic part number and manufacturers' part numbers; lists electrical

characteristics; identifies more than 900 discontinued devices; and includes alternate sources. The cross-referenced guide now includes interface ICs for consumer equipment and modular and hybrid device information.

D.A.T.A. Business Publishing, 9889 Willow Creek Road, P.O. Box 26875, San Diego, CA 92126; 619-578-7600.



CALL TOLL FREE 800-824-2873
 Include work address and phone number for Free Catalog.

DIGITAL MULTIMETERS

BECKMAN
Beckman Industrial

All 300, HD, and Circuitmate series
 All accessories in stock

MODEL	PRICE
HD100	\$169
HD110	\$199
HD130	\$259
HD140	\$279
300	\$120
310	\$145
310B	\$155
320	\$179
320B	\$189
330	\$219
350	\$229
360	\$289
4410	\$239

FLUKE

Autorange Analog display
 Touchhold function
 0.3% accuracy Heavy duty

MODEL	PRICE	MODEL	PRICE
21	\$ 99	75	\$119
23	\$149	77	\$149
25	\$199	8010A	\$299
27	\$259	8012A	\$359
37	\$249	8020B	\$219
52	\$169	8024B	\$259
73	\$ 79	8050A	\$399

Hand held DMM
FLUKE 23YEL
SALE \$120
LIST \$145

WAYNE KERR

MODEL	PRICE
4210	\$2650
4225	\$1950

SCOPES

HITACHI
 Hitachi
 Denshi America, Ltd.

All 20 models in stock
 2-3 year warranties
 20-100 MHz

MODEL	PRICE
V209	\$ 895
V222	\$ 530
V422	\$ 740
V425	\$ 796
V660	\$ 985
V665	\$1255
V680	\$1341
V1060	\$1345
V1065	\$1615
V1100A	\$2116

HITACHI V-509
 Portable Dual Trace Scope
SALE \$1199
LIST \$1445

IWATSU

All 14 models in stock
 2-3 year warranties
 20-250 MHz

MODEL	PRICE
5702	\$ 535
5705	\$ 899
5706	\$ 749
5710	\$1245
5711	\$1695
5712	\$2999

POWER SOURCES

POWER DESIGNS

Low and high voltage power sources
 1-5 year warranties

MODEL	PRICE
TP340	\$ 805
TP343A	\$ 855
TW347D	\$ 855
TW5005D	\$ 625
TW6050D	\$1075
2K20A	\$1095
2020B	\$ 850
4050D	\$ 805
5020	\$ 925
6010D	\$ 495
6150	\$ 775

USED TEST EQUIPMENT, TOO!—OVER 3,000 MODELS AVAILABLE AT HUGE DISCOUNTS WITH WARRANTIES!

■ Quantity Discounts Available ■ Dealers Welcome ■ Freight and Tax Extra ■ Immediate Availability of Equipment

United States Instrument Rentals, Inc.

A.U.S. Leasing Company
 2988 Campus Drive
 San Mateo, CA 94403

Circle (13) on Reply Card
 September 1988 *Electronic Servicing & Technology* 25

Electronics and automobiles: A revolution in the making

By Mike Ergo

You may not be able to hear it, but a revolution is taking place. It's an electronics revolution, and it's taking place in the automobile industry. Cars of every make and model are being bombarded with electronics. Some of the electronics are integral parts of the automobile; still other devices fall under the category of gadgetry or creature comforts. In fact, it is estimated that the average car leaving the assembly plant today contains between \$400 and \$600 worth of electronics; that number will be close to \$2,500 by the year 1990.

How are electronics being used on the automobile? Where are they located, and how are they being serviced? In order to answer these and other questions about automotive electronics, let's first

Ergo is president of Ergo & Associates, consultants to the automotive industry.

take a quick look at the history of automotive electronics.

In the beginning

In 1839, Robert Anderson of Scotland drove the first carriage powered by a primitive electric motor. In 1851, W.M. Storm patented an engine in which gas was compressed before being ignited by an electric jump spark. The use of electricity was becoming so popular on the automobile that, in 1906, Buick included a storage battery as standard equipment. The year 1911 saw a major breakthrough in starting systems with the installation of the first successful self-starter on Cadillacs. This major achievement was the work of C.F. Kettering. Next came lighting changes, turn signals, gauges and, of course, radios. Cruise controls showed up on Chryslers and Cadillacs in 1957. In 1962, Pontiac

offered the first fully transistorized ignition system. As they say, the rest is history.

By now we're all pretty familiar with the many electrical/electronic options on today's automobiles. For example, power seats, windows and door locks are very common. Automotive sound systems are as elaborate as you can afford, and it doesn't take an electronics whiz to notice the difference under the hood of a new car, or the cockpit-like appearance of the dash.

Under the hood today

What does all this mean to the future electronics servicer, and where is the automotive electronics revolution headed? Let's take a closer look at the sophistication of the electronics currently used on today's automobiles. For the past several years, every gasoline-powered car sold in the United States has had an on-board computer that controls engine performance. The primary purpose of this computer is to control exhaust emissions and maximize fuel economy. Started in the mid-1970s, this electronics evolution began as a direct result of tough government regulations from the EPA (Environmental Protection Agency) dealing with harmful exhaust emissions and fuel economy.

Today's exhaust emissions are controlled by a 16-bit, microprocessor-based computer using several sensors for information sources. The main source of information, in this direct feedback system, is the oxygen (O₂) sensor. (See Figure 1 for a basic understanding of how the system works.) Because carburetors are quickly becoming extinct, this same computer system has been adapted for fuel-injected engines. This innovation promises to be the way of the future.

Other familiar components also are disappearing. For instance, several GM engines use C³I, which stands for com-



Electronic navigation systems will help drivers find their way around without consulting maps or stopping to ask for directions.

puter-controlled coil ignition system. This ignition system uses Hall-effect sensors to sense both crankshaft and camshaft positioning, eliminating the need for a distributor. Also used on some cars is a direct ignition system that eliminates high-voltage spark-plug wires, which can generate unwanted noise in a computer system. Instead, primary voltage is dispersed to each spark plug, which contains a mini-ignition coil mounted on the end of the plug itself.

And in the passenger compartment...

Aside from changes under the hood, major changes have taken place in the passenger compartment as well. The biggest changes have come in the form of electronic instrumentation, electronic heater/air-conditioning controls and sophisticated entertainment systems. Many cars, both domestic and foreign, now use digital instrument clusters. Basic clusters have a digital speedometer in either a back-lit LCD format or a vacuum fluorescent format.

More elaborate clusters, such as those found in a Cadillac or Corvette, include digital displays of oil pressure, fuel level, water temperature, engine RPM and even odometer readings. These clusters also are microprocessor-based and use PROMS to store important odometer information. Some clusters incorporate separate circuitry to perform trip computations. These computations include instantaneous and average miles-per-gallon readings, estimated time of arrival, estimated fuel consumption and instantaneous mileage range based on existing fuel levels.

Heater/air-conditioning controls also are microprocessor-based. Using driver information inputs and information from sensors that measure both inside and outside temperature, the passenger compartment temperature is maintained within ± 1 degree. This feat is accomplished by continually adjusting the blower-fan speed, heater control-valve settings and plenum door positioning.

The sound systems

Regardless of whether you listen to the radio when you're driving, it's pretty hard to ignore the sophisticated sound/entertainment systems that are available on today's cars. Elaborate sound systems that can cost several thousands of dollars are being installed in today's vehicles. These systems not only include electronically tuned

Philips ECG's Master Guide gives you all the replacement semiconductor information you'll ever need.



For speed, accuracy and ease-of-use, nothing beats the Philips ECG® Master Guide!

- Contains technical data for 4000 Philips ECG semiconductors that replace over 240,000 industry part numbers
- Contains the most accurate cross-references available.
- New edition has 13,000 additional cross-references

and 230 new devices

All this, all in one book. Contact your Philips ECG distributor or call 1-800-225-8326. It just might be the smartest call you make all week.

Circle (14) on Reply Card

The Smart Choice.
Philips ECG

A North American Philips Company

Ensure pinpoint accuracy with the ECG® DM-410 Multimeter.

The ECG DM-410 4½ digit multimeter ensures a level of accuracy that's hard to beat! And it's loaded with features:

- 0.05% basic DC accuracy
- 7 functions, 26 ranges
- Data hold
- 10 amps AC/DC
- Audible and visual continuity tests
- Measures down to 0.01 ohms
- RF shielded
- Diode test



Contact your ECG products distributor or call 1-800-225-8326. It just might be the smartest call you make all week.

Circle (15) on Reply Card

The Smart Choice.
Philips ECG

A North American Philips Company

Philips ECG's Cable Converter brings in the signal loud and clear!



- The TV 2000 adapts any TV set to cable ready
- Remote control adjusts volume, turns TV on/off, has direct channel selection and channel stepping
- Receives up to 139 VHF, UHF and cable channels
- Separate video and audio outputs for direct connection to VCR and stereo systems
- Stores up to 12 user-selected channels for quick selection

Contact your Philips ECG distributor or call 1-800-225-8326. It just might be the smartest call you make all week.

Circle (16) on Reply Card

The Smart Choice.
Philips ECG

A North American Philips Company

AM/FM receivers, they also incorporate cassette players and compact disc players; they also should include digital audiotape (DAT) players one day soon. Almost all of these units are microprocessor-based, using the latest LSI (large-scale integration) techniques. Most offer features such as digital readout, infrared remote controls, music search on tape and built-in anti-theft circuitry.

One of the most sophisticated displays of creature comforts is a standard feature on GM's Buick Riviera. It is a touch-sensitive CRT (cathode ray tube) that contains the controls for the heater/air conditioner and the radio. To control the

radio functions, you simply touch the screen and a picture of a radio appears. Touching the appropriate part of the picture gives the desired results. Also included in the Buick CRT system is an extensive set of self-diagnostics to aid mechanics in troubleshooting engine-related problems.

Other electronic features found on today's cars include anti-lock braking systems (ABS), electrically powered and heated rear-view mirrors, electric seats with memories, synthesized-voice warning systems that monitor vital engine/car parameters, and a myriad of other options.

If today's innovations aren't enough to make the mind wonder, let's take a look at what's coming in the future. Looking first at the drive train, in the future we should find a camless engine, where valves are activated by computer-controlled solenoids. Couple this modernistic engine with electronic power steering, electronically controlled 4-wheel drive and 4-wheel steering, add a computer-controlled suspension system, and you have a futuristic drive train.

What about safety? For a start, many of the basic functions such as headlights, wipers and heater/air-conditioner controls should be controlled directly by voice—voice activation and recognition. (See Figure 2.) Add a radar-type collision-avoidance system mounted in the front and rear bumpers—that should keep you from engaging in head-on and rear-end collisions. Now, to make sure you get where you are going, you will have to have a navigation system. Don't laugh—this CRT system will show you detailed maps of any city, down to the side streets. It will also show your position relative to the streets and highways and is accurate within 40 feet. A system will soon be available from the factory on an OEM (original equipment manufacturer) level. A picture of such a system, manufactured by ETAK, is shown on page 26. The ETAK system uses a built-in electronic gyroscope and speed sensors on the wheels to monitor positioning. Of course, a microprocessor does the calculations.

To make it easier for the driver to monitor vital engine information such as temperature, oil pressure, rpms and car speed, future cars may have a projection-type instrument cluster that will use 3D holography to project images in front of you so you don't have to move your head and refocus to check your car's vitals. At the same time, you will be able to see the road because the holographic images are see-through.

All of these wonderful devices will be connected together with only one pair of wires. Everything will be controlled by a multiplexed signal originating from a central body computer. In other words, all the devices including lighting will be smart devices, capable of decoding computer commands.

Are you convinced that an electronics revolution is taking place in the automotive industry? If you are involved in electronics at any level, you stand to be right in the path of the revolution.

ES&T

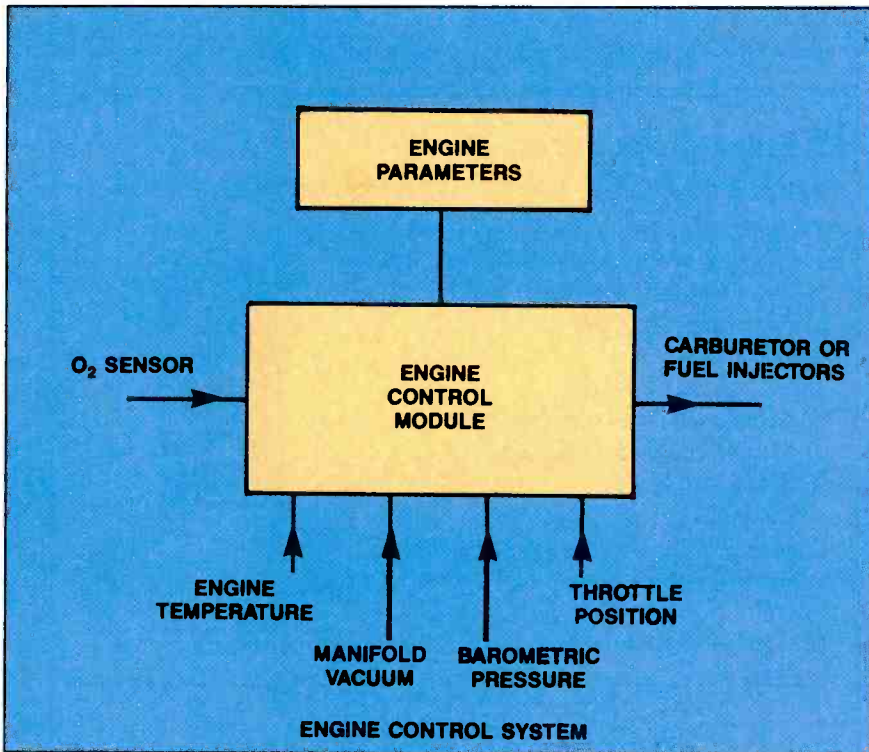

Figure 1. Today's cars already include electronic engine control. As shown in this block diagram, the electronic controls sense engine conditions and driver input, then operate the car accordingly.

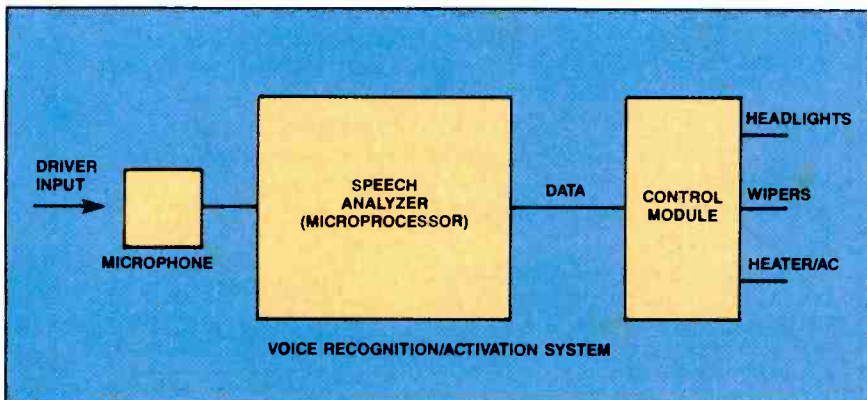

Figure 2. Voice-activated devices will allow drivers to operate such things as headlights and windshield wipers without taking their attention off of their driving.

Unusual lines in the picture

By Homer Davidson, CET

The side effects of many failures show up in the TV picture. Learning to read the often distinctive lines they create can help you diagnose the defect.

Although the key word in the phrase *unwanted lines in the picture* is *unwanted*, there is one consolation: They often provide visible side effects of the defect. If they're visible, they may be identifiable, which would provide the servicer with a road map to troubleshooting the problem. Indeed, unwanted lines and dots on the screen often arrange themselves into recognizable families whose patterns can help you diagnose the sources of the problems.

During the years before color TV, only two types of unwanted lines ordinarily appeared on the CRT screen: one black Barkhausen and one white drive line, both vertical. These lines usually were not difficult to remove. With transistorized TVs, however, you often run into unusual lines.

Reading between the lines

Unusual lines, which might be vertical, horizontal, diagonal or a combination of the three, might appear almost anywhere on the raster. Some are stable; others vary constantly.

These lines are unusual also because of the variety of their appearances and the circuit problems that cause them:

- Retrace lines at the top of the picture often occur as a result of sync or vertical problems.
- Horizontal firing lines might be produced by strong arcs in the yoke, focus control or CRT socket. They also can be caused by HV arcs.
- HV arcing spots are displayed as a result of problems with a tripler, flyback or CRT-anode lead.
- Horizontal hum bars usually indicate poor filtering in the boost supply.

- Shaded vertical bars at the left hint of poor filtering in the boost supply.
- Several vertical "jail bars" on the left side of the screen usually indicate defective electrolytic capacitors in the AGC, sync and horizontal-output circuits.

Many other lines come from signals outside the television receiver. Therefore, before starting the testing analysis, determine if the lines are caused by a

nated, the noise is coming from the antenna. If the lines or spots don't change, the problem is in the chassis.

Lines and spots

The focus control is sometimes the source of small lines and spots in the picture. To determine whether the focus control is the problem, rotate it in both directions and notice if the lines increase in intensity or

Glossary

Barkhausen lines: Barkhausen-Kurz oscillation or Barkhausen oscillation, named after H. Barkhausen and K. Kurz, 20th century German scientists, is ultrahigh-frequency oscillation produced in a triode oscillator by means of a positively biased grid. This oscillation causes the cathode electrons passing through it to oscillate at a frequency characteristic of the tube and applied voltages.

Firing lines: Firing lines are caused by amplitude-modulated noise such as arcing, similar to that caused by firing automobile spark plugs that are not properly suppressed.

Retrace lines: The signal voltage during the interval in which the electron beam is pulled back to the top of the screen to begin tracing out the next field of the picture is at a level that is designed to turn off the electron beam and, therefore, blank the screen. Theoretically, then, the screen should be dark during the vertical retrace interval. In the case when the received signal is weak or the brightness is turned up high, the retrace action may be seen as a series of widely-spaced, bright lines sloping diagonally upward to the right. Modern televisions have retrace blanking circuits to overcome this problem.

defect in the TV or by a signal picked up by the antenna from some outside source.

To determine if the problem is internal or external, disconnect the antenna lead wire and short between the receiver's antenna terminals. This maneuver usually eliminates noises from motors, neon lights and high-line arcs. If the noise on the screen is reduced or elimi-

disappear as the picture focus changes. If the control is good, the focus should change smoothly with little or no effect on the lines. A defective focus control might also emit a high-frequency squeal as the control is rotated. A corroded focus control might produce noise dots or lines on the screen of another TV nearby. If symptoms point to a problem with the focus control, replace it. If a new focus control

Davidson is the TV servicing consultant for ES&T.

Arcing horizontal lines JCPenney CTC90JL chassis

In this chassis, I could hear a faint, irregular but rapid arcing when the focus control was rotated. At the same time, several arcing lines flashed across the raster. I suspected either the focus control, the tripler or the CRT harness and socket. The sound was loudest at the CRT socket. Replacing the entire CRT socket and harness assembly solved the horizontal arcing lines.

Horizontal lines caused by arcing might be produced by a defective focus control. The two controls mounted on ceramic are the focus control, on top, and the screen-adjustment control, on the bottom. Rotate the focus control and notice on the picture tube if the arcing stops.

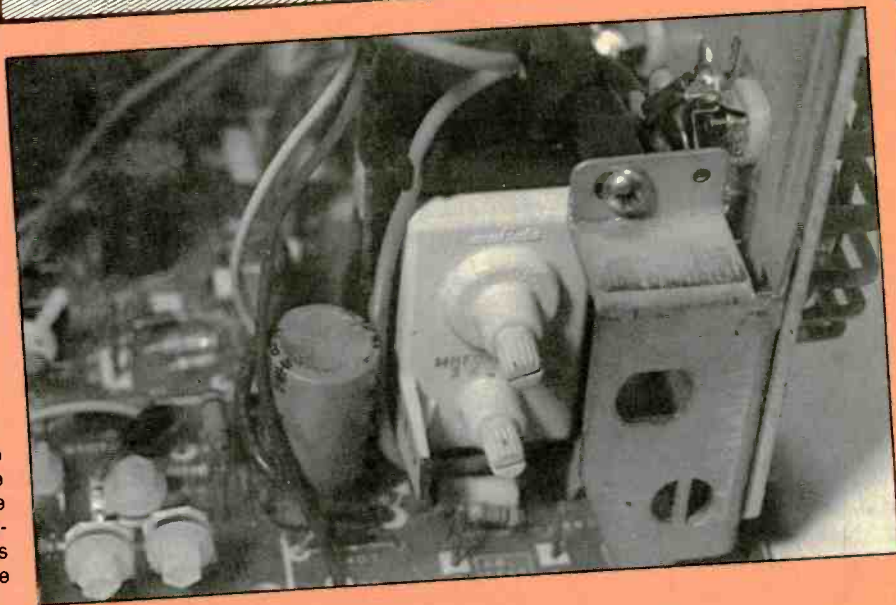

Retrace lines at the top Gold Star model CR-401 portable

In this set, I could not reduce the brightness enough to eliminate the retrace lines at the top. About +32V was measured at the collectors of the three color video-output transistors. Tracing the +162V source back to its beginning as a flyback-powered supply, I found the D₅₁₀ diode (see Figure 1) virtually shorted. Also, protective resistor R₅₂₁ was open. Replacing the diode and R₅₂₁ fuse/resistor plus doing the usual adjustments brought a good picture to a normal screen, without retrace lines.

Perhaps a few words of explanation are needed here. Each color video-output collector is connected to its matching CRT cathode by a 4,700Ω resistor. Therefore, the collector and the CRT cathode have about the same +130Vdc voltage. Loss of the +162V supply reduces the CRT cathode voltages and forces the CRT to operate with far less than normal bias, thus producing excessive brightness.



Retrace lines at the top of the picture might result from defective components in the luminance, picture tube or vertical circuits.

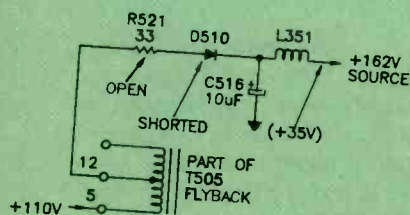

Figure 1. Retrace lines at the top of the screen in a CR-401 Gold Star portable were caused by an open R₅₂₁ surge resistor and a very leaky D₅₁₀. Replacing D₅₁₀ and 33Ω protective resistor R₅₂₁ eliminated the retrace lines by reducing the excessive brightness. The defective components had reduced the +162V supply, which reduced the CRT cathode voltages and operated the CRT at near zero grid bias. Check the 1870-1 Photofact.

removes all noise lines and spots, the analysis is finished.

Horizontal firing lines can be caused by an erratic yoke socket or loose connections. Some firing lines are similar to the picture symptoms caused by arcs: round and oval in shape and one line high. But others are much wider (horizontally) and brighter, appearing as bright flashes. Occasionally, firing lines remove a sizable part of the raster. Inspect the yoke socket, looking for burned marks or signs of arcing.

Arcing horizontal lines in the picture sometimes are caused by a defective CRT socket and wiring harness. Place your ear near the focus control while you rotate it. Then repeat by listening to the CRT socket while rotating the focus control. To determine whether arcing occurs in the CRT socket and harness, turn off the power and remove the CRT socket. Turn the power on, and keep away from the CRT and its harness while you rotate the focus control. (Some defective focus controls will arc when the CRT socket has been removed, but they seldom arc with the socket on the tube.)

Incidentally, many color receivers have the screen-grid and focus variable controls in the same package. If one control is defective, both are replaced together.

Retrace lines at the top

Several diagonal retrace lines are visible at the top of a normal-brightness picture when certain defects occur in the luminance, vertical or picture-tube circuits. Usually these retrace lines are blacked into invisibility. If the picture is too bright, the brightness cannot be turned down and retrace lines appear at the top of the raster, you should suspect incorrect dc voltages on the CRT, either grid or cathodes. A leaky video output transistor can cause the same symptoms, except the raster and retrace lines are all the same color: red, blue or green.

High-voltage arcs

Although high-voltage arc-over can occur anywhere in the high-voltage circuitry, when this symptom occurs, suspect a defective tripler, flyback transformer, picture tube or CRT anode cable. And don't overlook the possibility of arcing at the spark gap across the tripler unit. The arcing tripler or flyback sometimes might produce a dark screen with horizontal arcing lines in the raster. With the power off, take a look at the

NEW SERVICES FROM PTS

TUNERS



Varactor
Front ends
Standard

MODULES



Mother boards
Single function
Manufacturer's Updates

VCR



VHS
Beta
Portables

TVRO

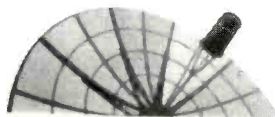

Receivers
Actuators & Arms
Down converters

■ PTS wants your repair business. And they have made some big changes at servicenters nationwide. New test equipment. New quality assurance programs. Even faster express service! And a new 800 number to serve you better. Call PTS today.

THE NEW

PTS

1-800-441-2371

Ask for the servicenter or distributor nearest you.

PTS Corporate Headquarters
P.O. Box 272
Bloomington, Indiana 47402

Circle (17) on Reply Card

Folded-over retrace lines RCA CTC97H television

Seven very bright, folded-over retrace lines were located at the top of the picture. Below these were several less-bright lines that were visible after I increased the brightness.

I checked all CRT circuits and voltages (including the grids and cathodes of the CRT, and the collectors of the color-video outputs) without finding anything out of tolerance. I concluded, therefore, that the problem might be in the vertical circuit. This is one of the few models that has a switch driver and switch resistors. These components add vertical sweep power only during the latter part of retrace and the beginning of trace when special power is needed to provide good linearity. At Q₁₉ switch transistor and Q₂₀ retrace switch transistor, the com-

mon collector dc voltage was low. DMM tests proved that 18Ω R₁₅₆ was open. (See Figure 2.) I replaced R₁₅₆, which returned the set to good vertical linearity without retrace lines. I also replaced Q₁₉ and Q₂₀ because experience has shown that these have a tendency toward failure later.

Figure 2. All dc voltages of the CRT were tested and found to be within tolerance. At second thought, those retrace lines appeared to be the result of a vertical system problem. A routine test of voltages revealed low voltage at the common collector of Q₁₈ (switch driver) and Q₂₀ (retrace switch). Of course, a serious defect in that 2-transistor circuit usually generates retrace lines at the top. Operation was normal after 18Ω R₁₅₆ was replaced.

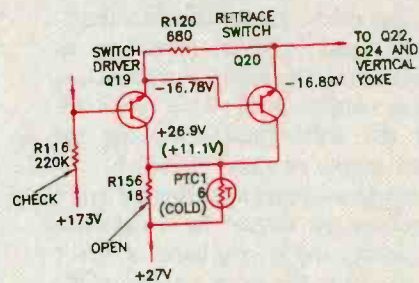

Intermittently arcing lines were easy to see on the raster of this set. Sometimes the arcing lines were visible when the focus control was rotated. At other times,

rotating the screen control apparently caused the arcing lines. And then, to make accurate analysis questionable, moving the T₃₀₂ flyback either started or

stopped the arc lines. A Fl177 component contains the focus control, screen control and flyback. I installed a new Fl177, which stopped all arcing lines.

Intermittently arcing lines Sanyo 91C530 portable

Rolling hum bars Zenith 25D56 color receiver

Replacing the Q₂₁₂ regulator transistor and the CR₂₁₁ zener diode in this set corrected the audio hum and the black bars in the picture. (See Figure 3.)

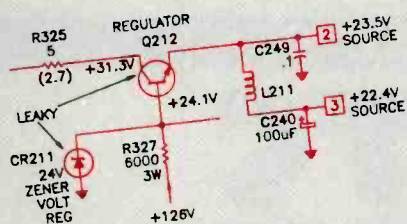

Figure 3. Four large black bars moving very slowly up the screen showed 120Hz ripple that was not being reduced enough by the Q₂₁₂ regulator in this Zenith 25DC56. Transistor and diode tests showed Q₂₁₂ and CR₂₁₁ zener diode were leaky. Replacing them removed the black bars and the audio hum.



Rolling hum bars usually are caused by defective filter capacitors in the low-voltage power supply. Extremely poor filtering can produce "vertical crawling" in the raster. An aluminum-can electrolytic capacitor (probably with several internal capacitance units) is shown at the left in the photograph.

CRT anode lead. It might not be hooked properly in the hole, causing arcing between the male connection and the CRT anode button. This defect can easily happen after the TV chassis has been replaced.

Arcs that are causing picture noise and lines are difficult to locate in a molded flyback transformer. Turn the brightness up and down, listen near the flyback and notice whether the noise disappears or becomes stronger. Arcing usually occurs internally between high-voltage windings and diodes.

Rolling hum bars

Most dark bars that move slowly up the screen are the result of dried-out, low-capacitance filter capacitors or problems with the low-voltage regulators. Many different symptoms can be caused by defective electrolytic filter capacitors. When symptoms occur that make you suspect a filter capacitor problem, parallel in turn each filter capacitor of the low-voltage power supplies. For testing, use about the same capacitance as that of the capacitor in the chassis. Always turn off the ac power and discharge other capacitors before adding the paralleling capacitors. Incidentally, excessive vertical "crawling" might result from poor filtering of the low-voltage power supply.

A leaky voltage-regulator transistor or incorrect B+ adjustment (usually too high) in the low-voltage power supply might allow excessive 120Hz in the B+ output (four horizontal bars floating slowly upward on the screen). Also, check the regulator and AFP transistors for leakages or shorts. Likewise, a shorted diode in the base circuit of the regulator transistor can produce dark bars in the raster because the defect interferes with voltage regulation.

Two black bars rolling up the screen of an RCA CTC89 television CRT probably are not caused by a defective electrolytic capacitor. (See Figure 4.) One reason is that a defective capacitor usually causes four black bars for 120Hz and not two bars (60Hz). Instead, the diodes are the prime suspects; one can open or nearly short and change the 120Hz to 60Hz. Using the DMM diode test, check all the diodes including the bridge diodes, regulator diodes and start/run switching diodes. If necessary, switch to the resistance ranges during leakage tests, or disconnect one lead of each questionable diode for a more accurate leakage test.

Start-up in the RCA CTC89 uses diodes as switches to change two power loads from start-up to run power flows. These power loads are the +26.5V and +20.5V supplies for the horizontal oscillator and driver stages. During each power-on, two temporary dc voltages are produced for the start-up procedure. These voltages are sufficient to start the horizontal oscillator and driver (the output transistor already has steady B+). Therefore, the horizontal and all receive

er functions begin to operate. The start-up circuit must then be disconnected because it is not powerful enough to support the entire load. This is the end of start-up. Five start-run diodes switch from conductive to non-conductive states according to the polarity of voltages across them. (More about this later.) Also, CR₃₀₅ and CR₃₀₃ are in series for reasons not explained. In this article they are listed as CR₃₀₅/CR₃₀₃ and treated as one diode.

Up to 50% Savings on Probes



Model SP100
Switchable 1X-10X \$ **43.**

Performance
Guaranteed

TEST PROBES, INC. 

9178 Brown Deer Road
San Diego, CA 92121

Call toll free for information
and free catalog:

1-800-368-5719
1-800-643-8382 in CA

ORDER FROM THESE DISTRIBUTORS

Or Phone Toll Free for the Distributor Nearest You



1-800-535-9593
1-800-462-9520 LA

contact east Metermaster

1-800-225-5370
(617) 682-2000 MA

1-800-962-8128
(213) 685-4340 CA



1-800-527-5018
(214) 550-1923 TX



1-800-363-6592 Canada
1-800-363-7601 QUE



(617) 879-7650



JENSEN TOOLS INC.
(602) 968-6231

BCS Canada
(416) 661-5585

ALLIED ELECTRONICS INC.
A SUBSIDIARY OF HALL MARK ELECTRONICS CORP.
1-800-433-5700, (817) 336-5401 TX

WESTCON INC.
(503) 283-0132 OR, (206) 223-1133 WA

Circle (18) on Reply Card

September 1988 *Electronic Servicing & Technology* 53

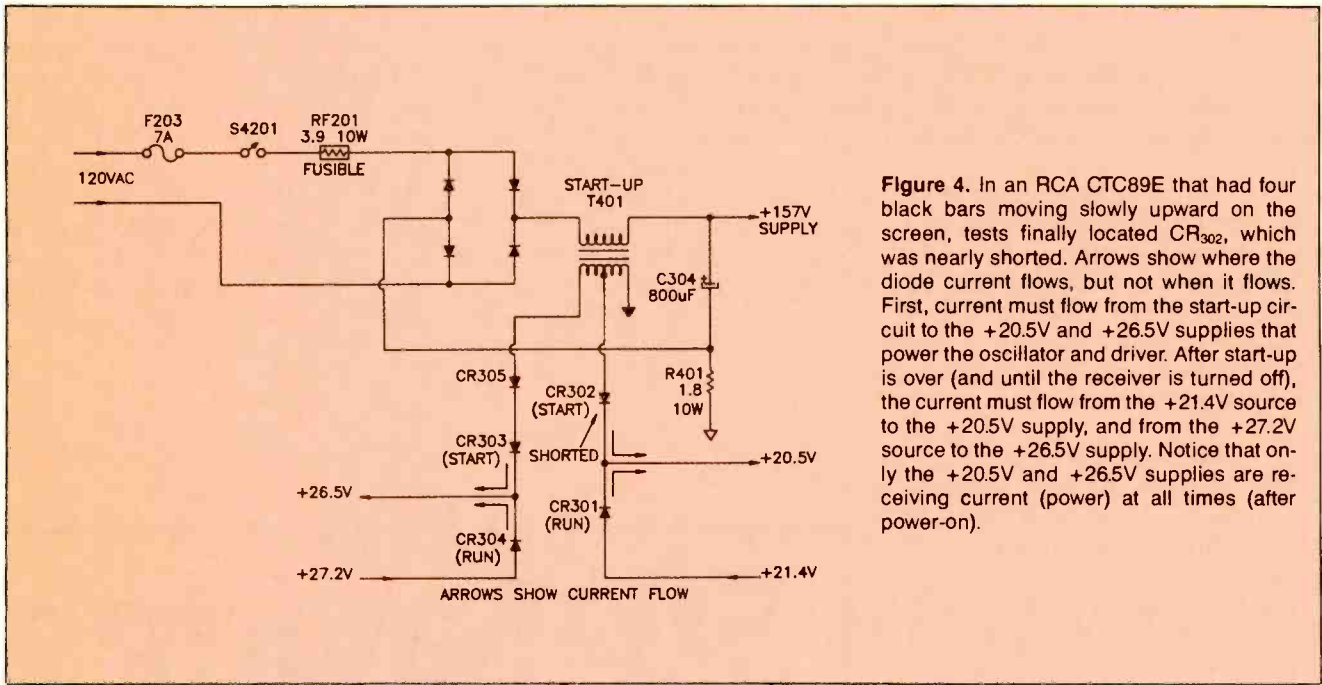

Figure 4. In an RCA CTC89E that had four black bars moving slowly upward on the screen, tests finally located CR₃₀₂, which was nearly shorted. Arrows show where the diode current flows, but not when it flows. First, current must flow from the start-up circuit to the +20.5V and +26.5V supplies that power the oscillator and driver. After start-up is over (and until the receiver is turned off), the current must flow from the +21.4V source to the +20.5V and +26.5V supplies. Notice that only the +20.5V and +26.5V supplies are receiving current (power) at all times (after power-on).

Lines in the center Sylvania E202 chassis

A band of horizontal lines appeared after I replaced the vertical IC₃₀₂. The complaint originally was about insufficient vertical height. An ECG794 universal transistor was installed as a replacement. Both vertical-output transistors

were tested and no defects were found; they were then replaced without any change in the symptoms.

Because the lines were not in the narrow vertical area of the picture at the beginning, I installed another ECG794 IC.

Those extra lines down the center were gone. Always watch for defective replacement ICs and transistors used in the video, IF and vertical circuits.

Picture lines on the left side of the screen showed wavy, pie-crust shapes. After testing many capacitors and resistors, I found 27Ω R₁₂₅ burned open and CR₄₀₃ operating quite warm. (See Figure 5.) Replacing those two HV-regulator components removed the wavy, pie-crust effect from the picture.

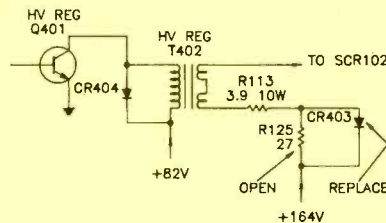

Wavy, pie-crust lines RCA CTC68 chassis

Figure 5. Picture lines at the left side of the screen showed wavy, pie-crust shapes on one RCA CTC68 CRT. Such problems often are in the horizontal circuit. Tests of capacitors and resistors in the horizontal circuit revealed that diode CR₄₀₃ was operating very warm and R₁₂₅ was burned open. Replacing CR₄₀₃ and 27Ω R₁₂₅ removed all unwanted wavy lines.

Dark bars on the left Panasonic TR-562A

This set had a dark picture on the left side of the screen, and the B+ boost voltage measured only +70.1V, although it should test at +113V. A very small elec-

trolytic capacitor is used to filter the boost circuits. In several cases of this symptom on this model of TV set, replacing the original 1μF C₄₂₀ with a 10μF

160V electrolytic removed all picture shading.

Equal in importance to the switching diodes are the voltage sources and current paths at the beginning. First, 120Vac power is rectified by the 4-diode bridge, producing 120Hz dcV pulses that are filtered and made peak-reading by $800\mu\text{F}$ C_{304} . The primary winding of T_{201} transformer is between the bridge and C_{304} .

The "kick-start" function of the start-up system operates by the charging surge of C_{304} current. At power-on, the current is very high, then it drops rapidly (as the capacitor charges) to a low, steady current. This powerful, short burst of dc primary current at each power-on produces, by induction, a narrow ac pulse across the T_{201} secondary winding, which has two outputs. The pulse from the T_{201} tap is rectified by series rectifier CR_{302} , and the output is filtered by capacitors of the +20.5V supply. (At the same time, diode CR_{305}/CR_{303} rectifies the T_{201} pulse, which is filtered by capacitors in the +26.5V supply. Note: we will continue to keep the two supplies separate by enclosing in parentheses the data from

this supply.) Both voltage supplies are necessary to activate the oscillator and driver stages.

Horizontal-sweep operations produce diode switching. The +21.4V (rectified from flyback pulses) exceeded the +20.5V supply by enough to switch CR_{301} , the run diode, into its conducting mode, thus passing current. (In the same way, +27.2V from the flyback was higher than the +26.5V supply.)

One more step remains. Power is flowing from horizontal-rectified dc voltages to their normal TV loads. However, the start-up circuit also is connected, and it might be damaged if allowed to continue. Therefore, the start-up circuit must be disconnected from the two power supplies. Switching diodes also do that job. CR_{302} (and CR_{305}/CR_{303}) have become reverse-biased, promptly becoming an open circuit because of the higher +20.5V supply versus the disappearance of dc voltages from the kick-start circuit. Now the two power supplies have the correct voltages and the start-up circuit is disconnected and inactive. Start-up is fin-

ished, and the TV receiver is operating normally with full power.

Lines in the center

Horizontal lines often appear through the center of the picture; these lines are caused by a defect in the video stages. The lines are visible only when a picture is being received; they are not visible on a raster without a picture. Sometimes firing lines appear, causing oscillation in the picture or tearing of sync lock. When those problems appear, check the capacitances of all electrolytic capacitors in the AGC circuit, look for burned collector resistors in video-amplifier circuits and examine the transistors for improper replacements.

Wavy, "pie-crust" lines

Defective components in both the horizontal and the vertical circuits can cause wavy, "pie-crust" lines. Keep in mind that pie-crusting caused by defective components in the horizontal or vertical circuit tend to appear on the left side of the picture, while pie-crusting that results from a horizontal-sweep def-

Weller® PPS. The unique answer to SMD re-work.

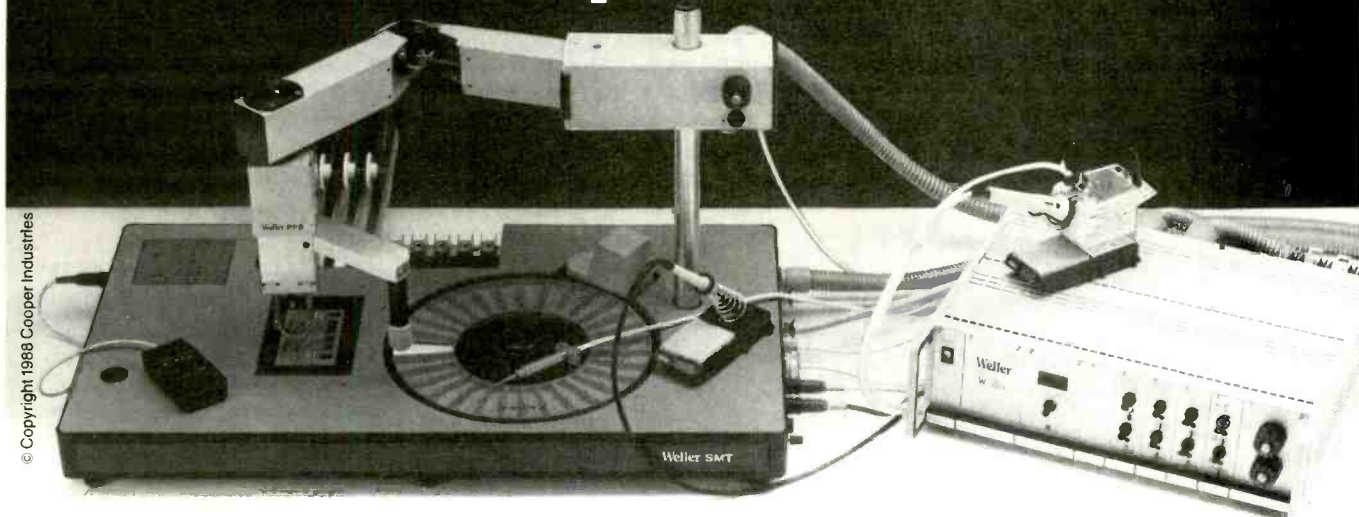

© Copyright 1988 Cooper Industries

Weller, the undisputed leader in soldering technology, is proud to introduce a unique piece of equipment, specifically designed for the repair, re-work and prototyping of circuit boards with lead-less and hybrid components and also for small production runs.

The Weller Pick-Place-Solder system is a self contained manual work station for the application of glue or solder paste and for the removal, positioning, soldering and desoldering of SMD's by means of temperature controlled inert gas. Call today for the full, state-of-the-art details.

CooperTools

The difference between work and workmanship.

BREWER-TITCHENER™ CAMPBELL® COVERT® CRESCENT® LUFKIN® MERRILL NICHOLSON® PLUMB® H.K. PORTER™ TURNER® WELLER® WIRE-WRAP® WISS® XCELITE®
CooperTools PO Box 728 Apex NC. 27502 USA Tel (919) 362-7510 Telex 579497
A division of Cooper Industries

Circle (19) on Reply Card

September 1988 *Electronic Servicing & Technology* 55

Figure 6. Vertical jail bars in the picture of a Sony KV-2644R were banished easily by replacing two electrolytic capacitors. C₅₃₉ (33 μ F) bypassed the +135V source to ground, and C₅₃₅ (10 μ F) bypassed the +197V supply to the +135V supply.

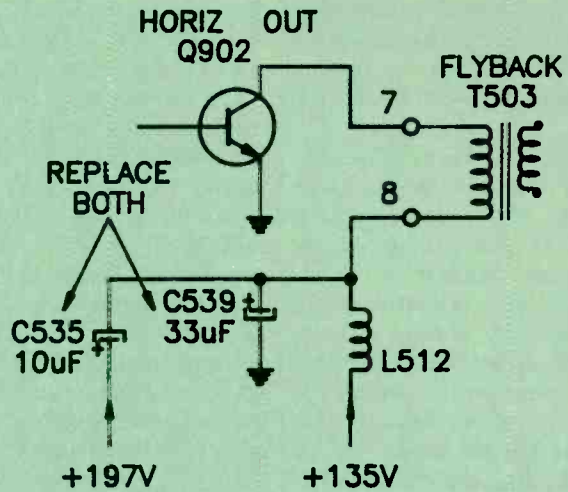

Green picture with retrace lines, followed by shutdown Zenith M1938W

This set showed rapid shut-down. After the back was removed, it was easy to see that the E5105 spark-gap was arcing. These picture-tube spark-gaps are located on the CRT board, near the prongs. Al-

ways replace burned or arcing spark-gaps with others of the 52-2240-06 original part numbers. One CRT element has one spark-gap inside the socket and another one separate from the socket. An arcing

spark-gap inside the tube socket causes arcing lines in the raster. An arcing inside spark-gap also can force the horizontal circuit into shut-down.

Vertical bars RCA CTC-107C chassis

In this set, vertical bars at the left of the screen were caused by an open collector resistor on Q₇₀₂. This 56k Ω R₇₁₂ resistor (see Figure 7) was open, thus changing to +0.97V the normal -2.53V at the Q₇₀₂ collector. This voltage, along with the vertical pulses, is sent with vertical blanking to pin 7 of U₇₀₁.

Figure 7. An RCA CTC107C showed vertical jail bars on the left side of the screen. A scope showed the jail-bar pulses at pin 7 of U₇₀₁ where vertical blanking should be. Checking back with a DMM and an ohmmeter located an open R₇₁₂ (56k Ω).

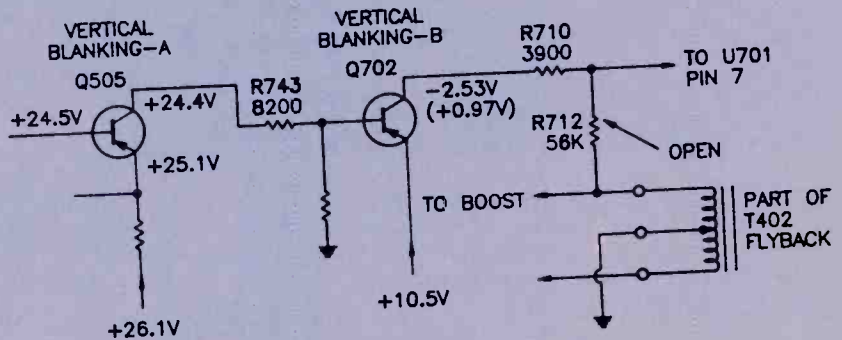

fect usually appears over the entire screen. In the vertical sync-separator stages, check for increased-value resistances, especially in the base and collector circuits. In the horizontal circuit, check for open electrolytic capacitors around the base circuit of the horizontal oscillator, perhaps in the phase detector. Also, look for burned resistors in the horizontal-output circuits.

Dark bars on the left

When vertical dark bars or a larger shaded area appear at the left side of the picture, one possible cause is poor filtering of the boost power-supply circuits. This boost voltage supplies the video-output transistors that usually drive the CRT cathodes. When this symptom appears, test the boost supply B+ output voltage. In many cases of dark shading or dark bars, the boost voltage will measure much lower than the schematic specifies. Perhaps the diode is defective, or the electrolytic filter is open.

Green picture with retrace lines

Another common set of symptoms are a green (or red or blue) picture with re-

The first few instrument readings and visual observations should allow a good technician to identify the major system that is involved.

trace lines quickly followed by shutdown. Sometimes the picture goes out of focus with arcing or firing lines in the picture. If these CRT symptoms are produced by an arcing focus control, shutdown probably will not occur (focus-control arcs seldom produce shutdown). When arcs are not visible or are otherwise easily located, it probably is faster to connect a 120Vac variable-voltage transformer. Start at some low line voltage, perhaps 50Vac, and increase it slowly until the picture is visible but does not have the problem. Then increase the line voltage until the problem occurs, but before shutdown, and make appropriate tests.

You often can see or hear the arc-over

in a spark-gap assembly. These spark-gaps are connected from several picture-tube elements to ground to protect the CRT from high-voltage arc-over.

When one color is dominant, go directly to the spark-gap for the CRT grid of that color. But when arcing occurs and the picture goes out of focus, check for arcing of the spark-gap that's across the focus control. Suspect a leaky tripler rectifier when the spark-gap across the high-voltage tripler is arcing.

Vertical bars

A likely cause of several vertical "jail bars" on the left side of the picture is an open electrolytic capacitor in the AGC circuit or in the horizontal-output circuits. Similar bars over the entire picture might originate from defective vertical blanking.

First, determine if the bars are in the raster alone, in the picture or in both. Change the selector to a channel without a station signal. Turn down the color control. If the bars remain, the problem almost certainly is in the sweep circuits. Next, fine-tune a station picture and notice whether the bars become brighter or lose intensity with the tuning.

Vertical lines that are varied by the signal usually originate in the AGC or video-amplifier circuits. Dark vertical bars at the left side often are caused by open electrolytic capacitors in the B+ voltage supply for the horizontal-output transistor. (See Figure 6.) Either temporarily replace any suspected capacitors or parallel them with known-good electrolytic capacitors for a test. Install new ones if these old capacitors are defective.

When dark vertical bars cover all the picture, check the vertical-blanking circuits. Look for leaky blanking diodes in video-amplifier circuits. Then test all components of the vertical-blanking, especially diodes, transistors and resistors.

Although TV malfunctions and problems occur in many dozens of ways with different symptoms, the first few instrument readings and visual observations should allow a good technician to identify the major system that is involved. If his previous experience has been extensive, the technician might have the ability to go further and identify the components that have failed.

Remember that some of the unusual lines described in this article might appear on the picture tube of almost any brand or model TV receiver. **ES&T**

VCR IDLER TIRES



Now you can do VCR repairs faster and easier than ever before. **Parts Express** is now offering the most comprehensive idler tire kit available. With this kit in your stock room you can do over 90% of idler assembly repair jobs without waiting for parts deliveries.



FREE
cross-reference
included

The kit includes a FREE cross-reference listing over 80 manufacturer assembly numbers and over 200 model numbers. 150 tires total, 10 each of 15 different sizes in a high quality storage case with separate compartments for each size. Worth over \$400 retail value.

\$55⁰⁰

#400-900

VCR IDLER ASSEMBLIES



Part #	Replacement for	(1-9)	(10-up)
430-010	Sharp NIDL0005	4.15	3.70
430-020	Sharp NIDL0006	4.35	3.90
430-030	Sharp NPLY-V0051	4.15	3.70
430-050	Pana VXPO329	1.40	.95
430-052	Pana VXPO344	1.40	.95
430-055	Pana VXPO401	1.95	1.55
430-060	Pana VXPO521	4.50	3.90
430-100	Fisher 4204-00300	7.80	6.90
430-105	Fisher 4804-00100	1.50	1.25
430-110	Fisher 4904-00900	7.50	6.75
430-120	RCA 164113	3.75	2.95
430-125	RCA 150614	3.95	3.25
430-130	HIT 6413111	5.20	4.65

FREE
CATALOG



Parts Express
International Inc.

CALL TOLL FREE
1-800-338-0531

340 E. First St., Dayton OH 45402
Local—1-513-222-0173

Circle (20) on Reply Card

What do you know about electronics—

Four-terminal networks

By Sam Wilson, CET

The first part of this installment of "What do you know about electronics?" is a continuation of the series that began last month, which deals with the network theorems and laws that have applications in electronic circuits. The theorems and laws are presented here as theory, without relying heavily on math. The objective is to show how the theorems and laws are applied.

Figure 1 shows a black box with input and output terminals. It is often called a 4-terminal network or 2-terminal pair. In order to work with this concept, you have to play by the rules. Terminals A and B are one pair of terminals; C and D are another pair of terminals. The rules are that you can make measurements or connections across either pair. However, you are not allowed to make measurements or connections between the pairs. For example, you can measure the resistance between A and B, but not between A and C or A and D.

Wilson is the electronics theory consultant for ES&T.

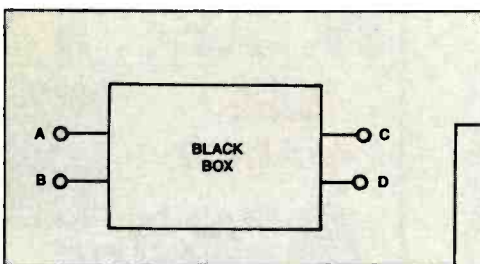

Figure 1. This black box with input and output terminals is often called a 4-terminal network or 2-terminal pair. Terminals A and B are one pair of terminals; C and D are another pair of terminals. You can make measurements or connections across either pair.

To begin the study of black box problems, we will consider only resistor circuits. This approach will give us some important applications without having to consider reactive components. Also, we can make all of the necessary measurements with an ohmmeter.

There are four—and only four—possible measurements that can be made with an ohmmeter. These measurements are called *resistive parameters*.

As you will see, if you want to make a circuit that is equivalent to the black box, you would choose resistive parameters. The four parameters that define the black box are:

- the input resistance with the output terminals open.
- the input resistance with the output terminals shorted.
- the output resistance with the input terminals open.
- the output resistance with the input terminals shorted.

It doesn't make any difference how many resistors you have in the box or how the resistors are connected. You can

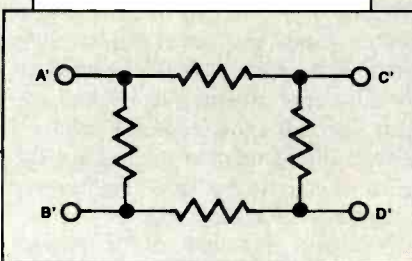

Figure 2. This circuit is sometimes called a delta or pi (π) because it is in roughly the shape of the Greek letter π .

represent the box with the simple circuit shown in Figure 2. This circuit is sometimes called a delta or pi (π) because it is in roughly the shape of the Greek letter π . Likewise, you can use the T-circuit in Figure 3 to represent the black box. This circuit is sometimes called a Y or wye, again because of its characteristic shape.

It should be immediately obvious that if either the delta or the wye-circuit can be used to represent the black box, then for every delta-circuit there is an equivalent wye. Also, for every wye there is an equivalent delta.

Let's stop here and look at a practical application. The delta-to-wye and wye-to-delta conversions can be used to simplify circuits. Suppose you are asked to calculate the resistance between X and Y in the circuit shown in Figure 4. You cannot solve that problem by determining series and parallel resistance. You can, however, replace delta-circuit ABC with wye-circuit LMN as shown. Now the circuit is a simple series-parallel network, and you can find the

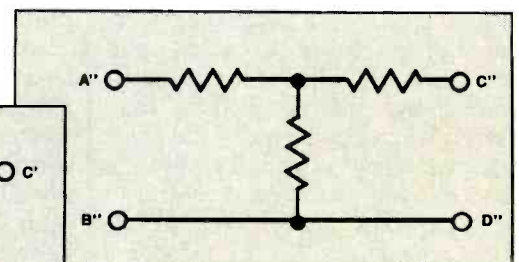

Figure 3. This circuit is sometimes called a Y or wye because of its characteristic shape.

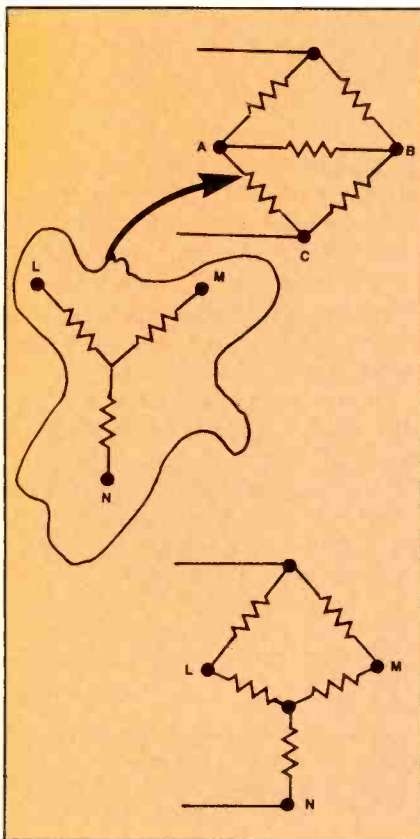

Figure 4. The delta-to-wye and wye-to-delta conversions can be used to simplify circuits. Although you cannot determine series and parallel resistance to calculate the resistance between X and Y, you can replace delta-circuit ABC with wye-circuit LMN as shown. Now the circuit is a simple series-parallel network, and you can find the resistance with series and parallel calculations.

resistance with series and parallel calculations.

Remember that we're only interested in what you can do with these theorems and laws. The mathematics are not of interest here. However, if you're one of those people who can't keep your fingers off your calculator, I've included the delta-wye and wye-delta transform equations in Figure 5. People who work with complicated networks often find it to their advantage to transform configurations in order to simplify the circuit.

Impedance matching

One method of matching impedances is to use a transformer. Of course, that won't work for the dc circuits under consideration here. However, the wye- or

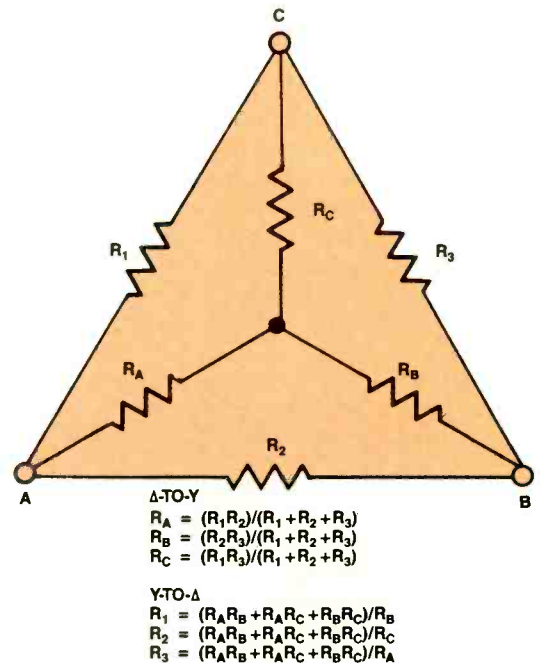

Figure 5. With complicated networks, the delta-wye and wye-delta transform equations can be used to transform configurations and simplify the circuit.

POPULAR SEMICONDUCTORS

2SD1341P	Original Sanyo	10 For \$19.90
2SD869	Original Toshiba	10 For \$19.90
BU208A	Original Toshiba	10 For \$19.90
2SD1398	Original Sanyo	10 For \$19.90
STR3115	Original Sanken	\$3.95 Ea.
STR3125	Original Sanken	\$3.95 Ea.
STR30120	Original Sanken	\$3.95 Ea.
STK4273	Original Sanken	(10 min.) \$9.95 Ea.
STK0080	Original Sanken	\$15.95 Ea.
375 Replacement		(10 min.) 99¢ Ea.



(10 min.) \$9.95 Ea.
\$15.95 Ea.
(10 min.) 99¢ Ea.

VCR PARTS

SANYO RF Modulator #4-1164-031600	\$17.95 Ea.
FISHER RF Modulator 191002-143-9-4300	\$17.95 Ea.
MITSUBISHI RF Modulator #PU57855-01	\$19.95 Ea.
TOSHIBA RF Modulator #MSU-911	\$19.95 Ea.
RCA Loading Belt 157061 or 157062	10/For \$8.50
FISHER Loading Belt 143-2-7504-01000	10/For \$8.50
GOLDSTAR Samsung Photo Interrupter	\$1.99 Ea.
RCA Idler 164113	\$3.25 Ea.
FISHER Idler 143-0-4204-00400	\$3.99 Ea.
SHARP Idler NIDL0005	\$2.99 Ea.
SHARP Idler NIDL0006	\$2.99 Ea.



POPULAR ITEMS

Sharp Flyback	FO009G	\$27.95 Ea.
Sharp Flyback	FO003G	\$27.95 Ea.
Sanyo Flyback	FO260	\$14.95 Ea.
Sanyo Flyback	FO192	\$14.95 Ea.
Tripler	523A/526A	\$9.95 Ea.
Sanyo Focus Divider	Z0064	\$11.95 Ea.
Minus-62	Freeze Spray	\$4.95 Ea.
Freon TF Clnr./Precision Clnr. Degreaser		\$4.95 Ea.
Chemtronics Solder — 1 Lb. Spool .031 Dia.		\$7.95 Lb.
Chem-Wick Lite	1/8 Dia. 25' Spool	\$5.50

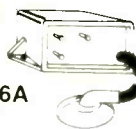

POPULAR CAPACITORS

100MFD/50 Volts	Radial	20 For \$10.00
4.7MFD/250 Volts	Radial	10 For \$5.50
10MFD/350 Volts	Radial	10 For 7.50
1000MFD/200 Volts	Snap-In	5 For \$12.50
680MFD/200 Volts	Snap-In	5 For \$12.50
100MFD/200 Volts	Radial	10 For \$12.50
47MFD/50 Volts	Radial	10 For \$4.50
10MFD/25 Volts	Non Polarized	10 For \$5.00
825MFD/250 Volts	Snap-In	\$3.95 Ea.
80MFD/450 Volts	Axial	10 For \$19.90



ASK FOR OUR FREE CATALOG !!!

CALL TOLL FREE: **1-800-628-1118**

IN PENNA CALL: **1-215-364-7667**

MAT ELECTRONICS

975 JAYMOR RD

SOUTHAMPTON PA 18966

T-circuit can be used with dc circuits. Impedance is an ac-circuit term, but many ac circuits have a pure resistance under certain conditions. One example is a resonant circuit that has only resistance at the resonant frequency. Another is a transmission line that can be terminated in a pure resistance.

Suppose the black box in Figure 1 is the circuit that connects a 300Ω transmission line to a 150Ω line. The

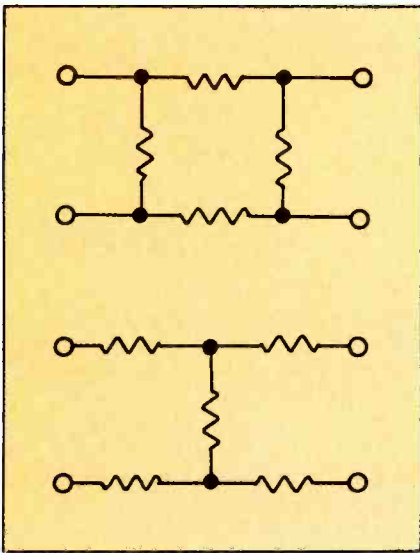

Figure 6. These configurations can be used for impedance matching when you are connecting to balanced transmission lines. They can be obtained directly from the delta- and wye-circuits.

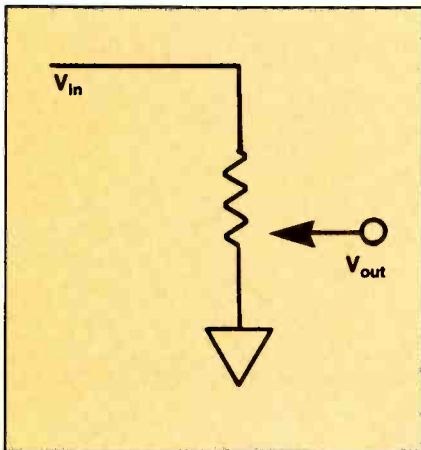

Figure 7. You can control the amplitude of a signal with a single resistor. The disadvantage is that, every time the variable resistor is adjusted to change the amplitude, the impedance between the input and output circuit changes.

300Ω line must “see” 300Ω looking into terminals A and B. Likewise, the 150Ω line must “see” 150Ω when looking into terminals C and D.

The black box can be used to match the two transmission lines. Assuming the lines are both unbalanced, as in the case of coaxial cable, either of the equivalent circuits in Figures 2 and 3 can be used to match the impedances.

There are several ways to determine the resistance values. They require a little bit of fancy mathematical footwork, which we can skip over for now. The important thing to know at this point is that by using only three resistors and either of the circuits in Figure 2 or 3, the unbalanced transmission lines can be hooked together. For balanced transmission lines, the configurations in

Figure 6 can be used. They can be obtained directly from the delta- and wye-circuits.

Attenuators

There has been some mixing of terms in this business. However, the words *pad* and *attenuator* are used to mean the same thing. They both reduce signal amplitude and, at the same time, match impedances. An attenuator (or pad) can produce either a fixed or variable attenuation of the signal.

You can control the amplitude of a signal with a single resistor as shown in Figure 7. This simple procedure has a disadvantage, however: Every time the variable resistor is adjusted to change the amplitude, the impedance between the input and output circuit changes.

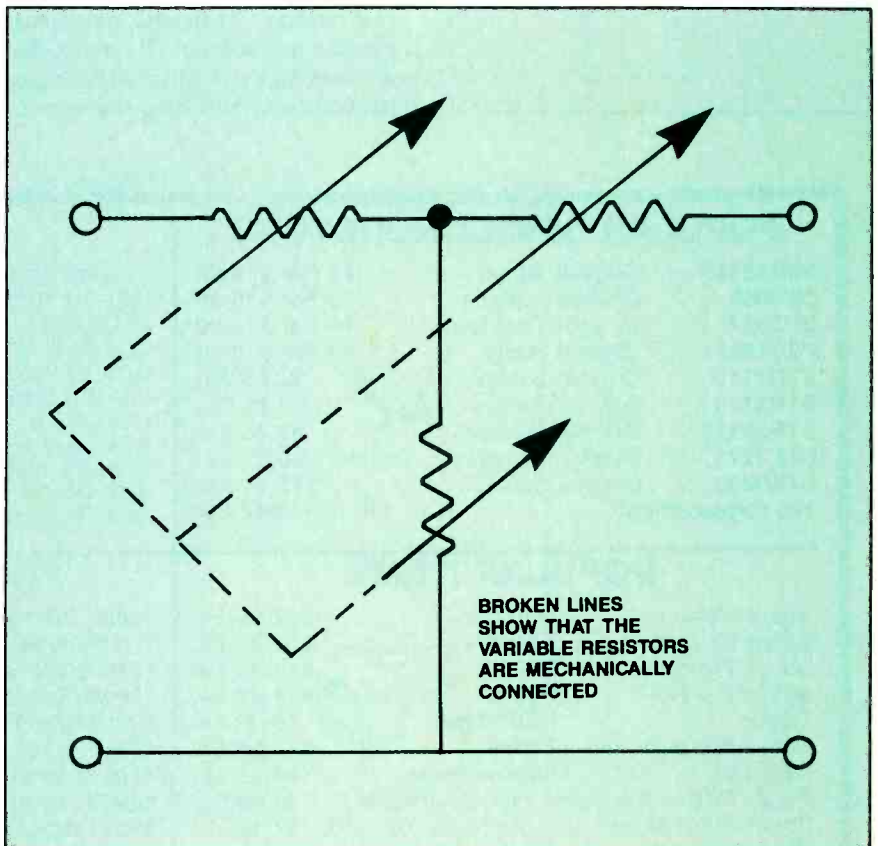

Figure 8. A signal's amplitude can be controlled with an attenuator to avoid the problem described in Figure 7. The variable resistors are ganged so that they are all adjusted at the same time. The attenuator makes it possible to control the amplitude of the signal delivered from one point to another. At the same time, it matches the impedances of the input and output circuits.

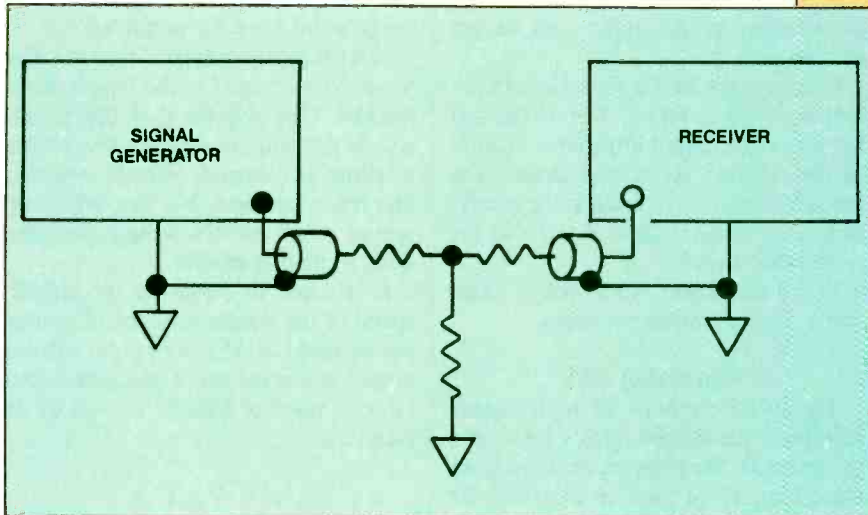

Figure 9. In this example of the use of an attenuator, the signal generator output impedance matches the receiver input impedance. The amount of signal delivered to the receiver can be varied without disturbing the impedance match.

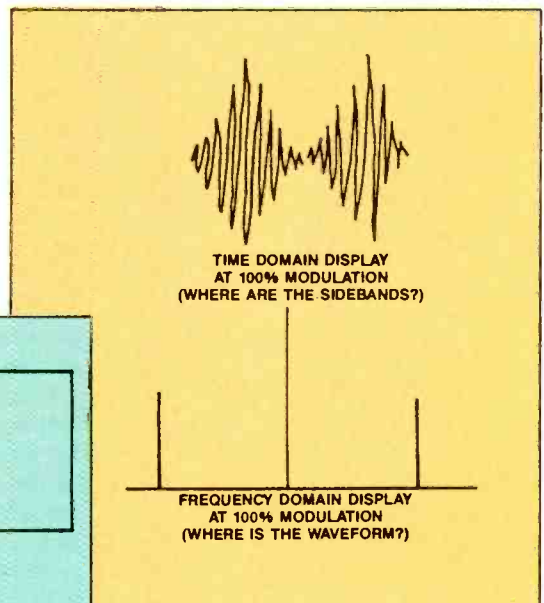

Figure 10. The usual methods of representing amplitude-modulated signals are shown here. These representations leave something to be desired because the time-domain display doesn't show the sidebands, and the frequency-domain display doesn't show the change in amplitude.

**Now You Can Learn Electronics
From VHS Video Tape!!!
UCANDO Now Has Four Video
Tapes Designed For The
Electronic Enthusiast.**

ELECTRONICS AND YOU—PART ONE DC
PRICE \$32.95
You will learn about **Series circuits, Parallel circuits**, the combination of **Series-Parallel circuits**, **Ohms Law, Voltage, Current and Resistance** as well as how to use the **Digital multimeter**.

ELECTRONICS AND YOU—PART TWO AC
PRICE \$32.95
You will learn about **AC theory, Coils Transformers, Capacitors, Filter circuits** and how they are used in actual circuits.

VCR MAINTENANCE AND REPAIR
PRICE \$32.95
This tape was designed for the average VCR user. No special tools or schooling are required for this tape. You will learn how to **clean the entire tape path in the VCR** as well as how to **replace some of the belts in the VCR.**

INTRODUCTION TO VCR REPAIR
PRICE \$59.95
You will learn how the VCR Processes the **Luminance, Chromance and Audio** signals in the VCR, in both the playback and record modes, you will also learn about the **Servo systems** used to control the **Capstan motor** and the **Video Drum Cylinder**. This tape also covers many more aspects of the VCR.

ORDER YOUR TAPES NOW!
VISA and MASTER CARD are accepted.
CALL: (513) 548-6113 or mail check or money order top:



UCANDO

**P.O. Box 386
Greenville,
Ohio 45331**

Circle (22) on Reply Card

FREE Heathkit® CATALOG



Featuring superior quality electronic products in kit and assembled form. Innovative home products, test instruments, self-study electronics courses. Challenging and educational kits for first-time as well as seasoned builders. Quality ready-to-use electronic products for homeowners, sports enthusiasts and professionals. All from Heath Company, a leader in the changing electronics market.

Send NOW for your **FREE** Heathkit Catalog.

Send to:
Heath Company, Dept. 030-692
Benton Harbor, Michigan 49022

Name _____

Address _____

City _____

State _____ Zip _____

A subsidiary of Zenith Electronics Corporation

108 full-color pages packed with the latest in high quality electronic products

Heathkit®
Heath Company

CL-792

ATTENTION TECHNICIANS

- ★ JOB OPENINGS
- ★ MONTHLY TECHNICAL TRAINING PROGRAM
- ★ BUSINESS MANAGEMENT TRAINING
- ★ LOW COST INSURANCE
- ★ CERTIFICATION
- ★ TECHNICAL SEMINARS

All of this in a nonprofit international association for technicians

FIND OUT MORE:



604 N. Jackson St.
Greencastle, IN 46135
317/653-8262

CONSOLIDATED ELECTRONICS

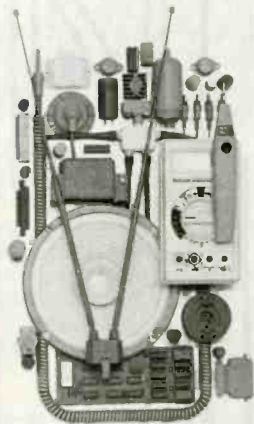

CONSUMER & INDUSTRIAL ELECTRONICS CATALOG • 17TH EDITION

THE ULTIMATE ELECTRONICS CATALOG.

Order your 260 page catalogue packed with over 10,000 money saving electronic parts and equipment. Send \$3.00 check or money order, or call 1-800-543-3568 today and use your Mastercard or Visa.
Consolidated Electronics, Incorporated
705 Watervliet Ave. Dayton, Ohio 45420-2599

NAME _____
ADDRESS _____
CITY _____
STATE _____ ZIP _____

Circle (23) on Reply Card

That problem can be eliminated by using an attenuator like the one shown in Figure 8. The variable resistors are ganged so that they are all adjusted at the same time. The attenuator makes it possible to control the amplitude of the signal delivered from one point to another. At the same time, it matches the impedances of the input and output circuits.

One example of the use of an attenuator is shown in Figure 9. Here the signal generator output impedance matches the receiver input impedance. The amount of signal delivered to the receiver can be varied without disturbing the impedance match.

In the next issue, we'll look at some active four-terminal networks.

Visualizing AM

The usual methods of representing amplitude-modulated signals are shown in Figure 10. These representations leave something to be desired because the time-domain display doesn't show the sidebands, and the frequency-domain display doesn't show the change in amplitude.

There is a third way of representing amplitude modulation (see Figures 11a through 11d), but you have to reach for it. It is not usually given in basic textbooks. It involves the use of rotating

phasors. Phasors are arrows that represent magnitude and phase angles.

As shown in Figure 11a, when the tip of a rotating phasor is projected on a time axis, the result is a pure sine wave. This assumes that the phasor is rotating at a constant speed. Only four points are marked, but in a total representation every point must be projected.

Note that the amplitude of the sine wave (V_M) is equal to the length of the phasor. The frequency of the phasor equals the number of complete phasor rotations per second. Voltage is used in this representation, but sine-wave current or power could also be represented with a rotating phasor.

It is usual to represent the angular speed of the rotating phasor in radians per second (ω). If you stop the rotating phasor at any instant of time, the instantaneous value of voltage is given by the equation

$$v = V_m \sin \omega t$$

where ωt = the angle in radians.

A phasor, rotating at a constant speed, can be used to represent the carrier of an AM signal.

Now, visualize the rotating carrier phasor with two counter-rotating (rotating in opposite directions) phasors at the tip. (See Figure 11b.) This discussion

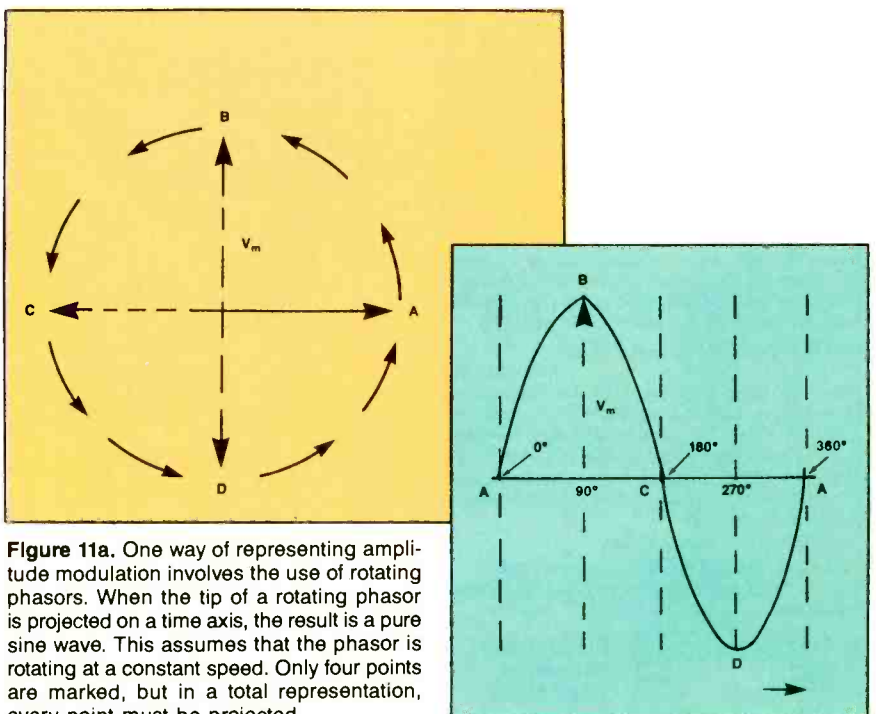

Figure 11a. One way of representing amplitude modulation involves the use of rotating phasors. When the tip of a rotating phasor is projected on a time axis, the result is a pure sine wave. This assumes that the phasor is rotating at a constant speed. Only four points are marked, but in a total representation, every point must be projected.

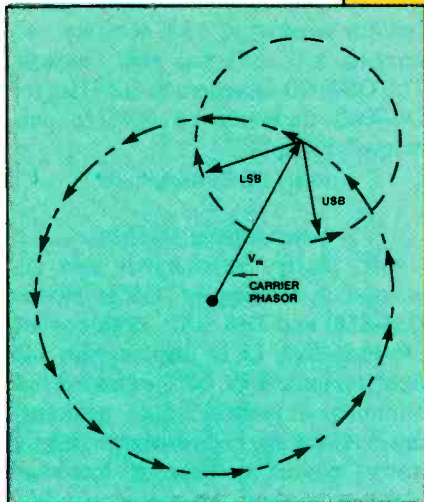

Figure 11b. Visualize the rotating carrier phasor with two counter-rotating (rotating in opposite directions) phasors at the tip. At the tip, each of the counter-rotating phasors has a length that is half the length of the carrier phasor. The counter-rotating phasors represent the upper sideband (USB) and lower sideband (LSB). When they are both pointing along the carrier phasor toward the origin (center of rotation), the resultant is zero. When they are pointing along the carrier phasor away from the origin, the resultant is twice the amplitude of the carrier. The LSB and USB rotating phasors, turning in opposite directions, change the length of the resultant.

will concern the condition for 100% modulation. At the tip, each of the counter-rotating phasors has a length that is half the length of the carrier phasor. (This is the point where the faint-hearted will drop out of the discussion.)

The counter-rotating phasors represent the upper sideband (USB) and lower sideband (LSB). When they are both pointing along the carrier phasor toward the origin (center of rotation), the resultant is zero.

When they are pointing along the carrier phasor away from the origin, the resultant is twice the amplitude of the carrier. The LSB and USB rotating phasors, turning in opposite directions, change the length of the resultant. The projection of the resultant on a time axis produces the familiar time domain waveform shown in Figure 10.

Now, imagine the two counter-rotat-

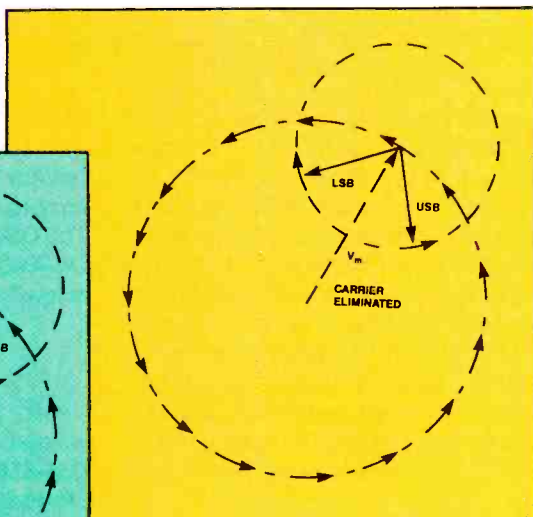

Figure 11c. Now, imagine the two counter-rotating phasors following the same circular path but without the carrier phasor. Project their resultant on a time axis. What you have is a double-sideband, suppressed-carrier signal.

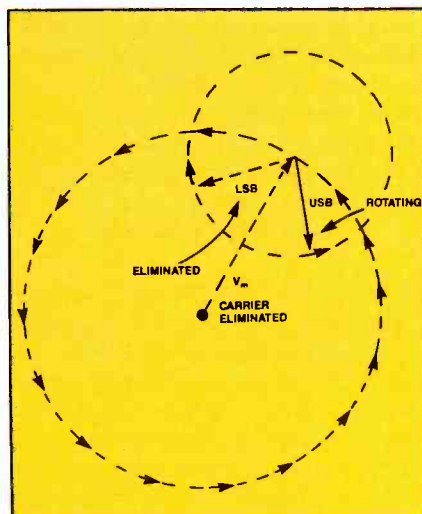

Figure 11d. Eliminate one of the sidebands. The other one is turning as it is moving around the circle. The projection of that sideband phasor is the signal waveform for a single-sideband, suppressed-carrier signal.

ing phasors following the same circular path but without the carrier phasor. This condition is shown in Figure 11c. Project their resultant on a time axis. What you have is a double-sideband, suppressed-carrier signal.

Having done that, eliminate one of the sidebands as shown in Figure 11d. The other one is turning as it is moving around the circle. The projection of that sideband phasor is the signal waveform for a single-sideband, suppressed-carrier signal.

ES&T

HITACHI SCOPES

15-25% Discount



V1060
100MHz
\$1285

V660 60MHz Dual Trace **\$949**
V422 40MHz Dual Trace **\$699**
V212 20MHz Dual Trace **\$379**

ELENCO PRODUCTS AT DISCOUNT PRICES!



\$498
MO-1252

Scopes

MO-1252 35MHz Dual Trace **\$498**
MO-1251 20MHz Dual Trace **\$349**
w/ Two 1x, 10x 100MHz probes, manual
S-3000 10MHz fully calibrated **\$239**
P2 Scope Probe 100MHz **\$23.95**
P1 Scope Probe 65MHz **\$19.95**

GF-8016 Function Generator with Freq. Counter



\$239.95

Sine, Square, Triangle
Pulse, Ramp, .2 to 2MHz
Frequency .1 thru 10MHz

GF-8015 without Freq. Meter \$179

Digital Triple Power Supply

Model XP-765 **\$239.95**



0-20V @ 1A
0-20V @ 1A
5V @ 5A

Fully Regulated, Short Circuit Protected
with 2 Limit Cont. 3 Separate Supplies

XP-660 w/ Analog Meters \$169.95

Color Convergence Generator



SG-200
\$69.95

Finest in the industry
10 rock steady patterns

Digital LCR Meter

\$138.95

Model
LC-1800

Measures
Inductors,
Capacitors,
Resistors

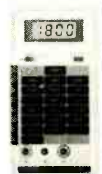

Multimeter with Cap. and Trans. Tester

\$55.95

Model
CM-1500A

8 Functions
with Case



C&S Sales Inc., 1245 Rosewood
Deerfield, IL 60015 (312) 541-0710
800-292-7711 ASK FOR CATALOG

15 Day Money Back Guarantee
2 Year Limited Guarantee
Add 5% for Postage (\$10 max)
IL Res., 7% Tax

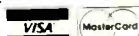

Circle (24) on Reply Card

Software packages

Designer Technology has introduced two software packages. The Part Substitution software helps technicians keep up-to-date on cross reference and substitution of parts. The menu-driven software handles more than 5,000 parts and substitutions. The Tech Bulletins software package provides technicians with modifications and answers to technical problems from more than 3,500 bulletins from 60 manufacturers and 20 service centers. Quarterly updates are available for both packages, which operate on IBM PC, XT, AT or other compatibles.

Circle (75) on Reply Card

Frequency counter

The model 714 1.3GHz universal frequency counter from *Simpson* is designed for R&D, breadboarding and testing applications. The counter



features three input ranges, X1 and X10 attenuation, a 150kHz low-pass filter and adjustable triggering on channels A and B. Accuracy for all functions is ± 1 count over a 0°C to 40°C operating range, with 1ppm stability and aging.

Circle (76) on Reply Card

Logic analysis kit

O.K. Industries has introduced the LK-680, a logic troubleshooting kit that combines three circuit-powered logic troubleshooting instruments into one kit. The kit includes a multipin IC logic monitor, a 20MHz logic probe, a 0.5Hz/500Hz switchable digital pulser and a probe-tip adapter with Micro-hook. The logic monitor adapts to ICs with up to 16 pins and has IC leg-extension pins for individual leg probing.

Circle (77) on Reply Card

Video alignment tape

Celebrity Research and Development Group has introduced the CAT2 profes-

sional 1/2-inch alignment tape system, a 2-cassette package that has 60 minutes of eight multipurpose test signals. The system features complete RF stability in playback, and the hi-fi audio track provides an accurate means of HD RF level and shape adjustment. Height and azimuth alignment of the stationary head is also allowed using the stereo and linear audio tracks. Audio tone segments provide visual confirmation of the frequency of the recorded material.

Circle (78) on Reply Card

Digital soldering/desoldering station

The MBT-210 soldering/desoldering station from *PACE* features a digital read-out display that indicates temperature selection and the actual tip temperature, which is settable within 1°. A heat-boost circuit compensates for heat sinks, and a temperature controller sustains tip temperature. The SnapVac vacuum generation system's rise time is 300% faster than electrically operated systems and eliminates lead resweat. The system features a static-dissipative desoldering handpiece.

Circle (79) on Reply Card

Software for IBM-PC compatibles

DatabasE DimensionS has developed a software package for IBM-PC-compatible computers. The package allows service centers to track the progress and location of items through the repair cycle. Features include automatic repair assignments to technicians, status tracking, parts orders and arrivals, and printing of warranty forms. Customers may call the computers by touch-tone phones.

Circle (80) on Reply Card

Soldering and brazing tool

The *McCormick Mini-Torch*, a soldering and brazing tool, has a 2,500° output from its torch head. Accessories include four sizes of replacement solder tips, 5-ounce Butane refills, and torch and solder heads. The tool will burn approximately one hour at a cost of 8 cents per refill.

Circle (81) on Reply Card

Oscilloscopes

Goldstar Precision has introduced the 7000 series oscilloscopes, which have 6-inch rectangular CRT displays with internal graticule, scale illumination and

photographic bezel. The scopes feature a TV-sync separation circuit, X-Y mode, 1mV/div sensitivity, $\pm 3\%$ accuracy, calibration indicators and gold contacts. The OS-7020 measures to 20MHz; the OS-7040 measures to 40MHz with delayed sweep.

Circle (82) on Reply Card

Autoranging DMMs

A.W. Sperry Instruments has announced its autoranging DMMs, models DM-6510 and DM-6910. Both contain 3 1/2-inch-digit LCD display with full function indicators, 50% extended resolution in all manual ranges, autoranging in all voltage and resistance ranges, instant continuity buzzers, low- and high-power ohms, electronic and fuse overload protection and recessed safety-designed input terminals.

Circle (83) on Reply Card

Current probe

The *AEMC* model MN103 current probe is designed to measure low ac currents. It outputs an ac voltage directly scaled to the current being measured and may be used with any DMM or other instrument having mV or Vac ranges. The 10A range covers 1mA to 12A, while the 100A range is used for currents between 1A and 120A. The frequency range is 50Hz to 500Hz.

Circle (84) on Reply Card

Heat tool elements

The *Eraser Company* has introduced 1/2-inch diameter elements for use with the Glo-Ring infrared heat tools. With

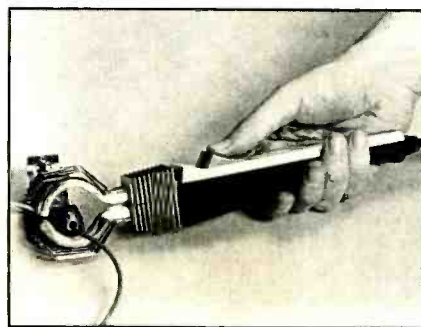

these elements, infrared heat is concentrated in a small area, allowing the unit to be used on small work pieces. Elements are available for either intermittent or continuous use and operate with the tool either on a 115V, 60Hz or 220/240V, 50Hz electrical supply.

Circle (85) on Reply Card

Field service kit

The No. 4c3k field service kit from *Micro-Circuits* allows technicians to open and close all connectors in a

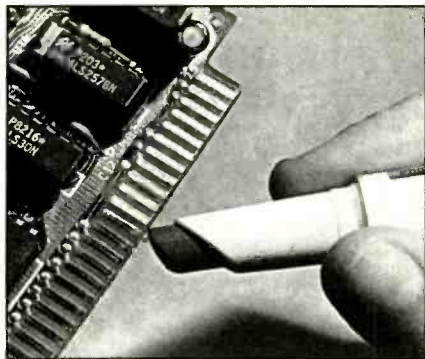

malfunctioning circuit to permanently clean up the one or two marginally defective connections that may be causing problems. The technician uses the applicator to rub on a thin layer of 4c3m gold replacement.

Circle (86) on Reply Card

Epoxy, cleanser

Formula 04001 epoxy from *HMC* is a 2-part structural adhesive that sets in 3 to 5 minutes, doesn't shrink and cures at room temperature. The epoxy contains no solvents and works on plastic, wood, metal, glass, stone or concrete. Formula 04040 hand cleanser removes resins, adhesives, epoxies, inks, putty and grease. Both come in job-sized packages.

Circle (87) on Reply Card

Logic analysis systems

BitWise has introduced two logic analysis systems that feature up to 320 channels, 64K depth, 16 trigger levels, 1ns resolution and full IBM XT/AT compatibility. The System-40 provides state and timing analysis on 40 channels at 25MHz and timing analysis on eight channels at 125MHz. The System-80 has 80 channels that can be used for single or dual timebase state or timing analysis; one or both groups of 40 channels can be used as eight channels of 125MHz timing analysis.

Circle (88) on Reply Card

RS-232 dataline monitor

B&B Electronics has introduced the model 232BOII Breakout-II version 2.1 software, which turns an IBM PC or compatible into an RS-232 dataline monitor. The unit features two

troubleshooting modes: interactive, for testing a single communications device; and monitor, for piggybacking onto an existing circuit to monitor two devices.

Circle (89) on Reply Card

TTL logic comparator

3M has introduced a full-spectrum TTL logic comparator that tests ICs in circuit at system speed. The unit tests tri-state, bi-directional, open collector ICs, PALs and bipolar ROMs. The comparator accommodates 8-, 14-, 18- and 20-pin DIPs, TTL and TTL compatible. A memory feature allows the unit to be left unattended until testing is complete.

Circle (90) on Reply Card

Digital storage scopes

Tektronix has introduced two handheld digital storage oscilloscopes that offer two channels, dual time base, 5MHz bandwidth for repetitive signals (2MHz

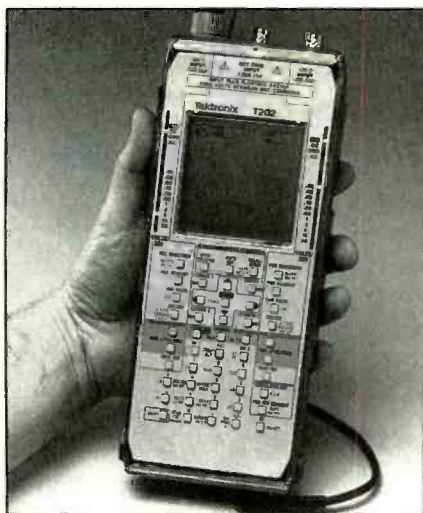

for single-shot) and a 20MS/s sampling rate with 20ns resolution. Features include signal processing, auto setup and storage of up to nine waveforms and nine front-panel settings in non-volatile memory. The T202 offers a traditional oscilloscope interface; the T201 has a calculator-like interface for left-to-right logical manipulations. The scopes weigh less than 2 pounds and come with a battery pack, a carrying case and probes.

Circle (91) on Reply Card

Battery replacement tool kit

Batt-Tronic has introduced a kit for replacing watch batteries. The kit contains a battery tester, a 7-piece
Continued on page 66.

Multiple Problems.

One Solution.



The 90 Series μP Board Tester

For microprocessor board trouble-shooting and service, nothing expands your diagnostic capabilities — and simplifies your operation — like the new Fluke 90 Series.

- 16 different preprogrammed tests make the 90 Series a powerful stand-alone trouble-shooting instrument.

- small enough (11"x6"x3") to find a home on every service bench.

FLUKE

COM-KYL
INC.

**COM-KYL is YOUR
Solution**
Call us today to find
out more about the
Fluke 90 Series

(408) 734-9660

(800) 538-1578

(Outside CA)

Circle (26) on Reply Card



FREE CATALOG TEST INSTRUMENTS & HARD-TO-FIND TOOLS

Packed with over 5,000 quality products for testing, repairing, and assembling electronic equipment. A full selection of test instruments, power protection equipment, precision hand tools, tool kits, soldering supplies, and much more. Products are shown in full color with detailed descriptions and pricing. All products come with a 100% satisfaction guarantee. SAME-DAY shipment program.

In a hurry to receive your catalog?

Call (800) 225-5370

In Massachusetts call (508) 682-2000

Contact East, Inc., Dept. R423
P.O. Box 786, No. Andover, MA 01845

Circle (25) on Reply Card

Technicians,
Get Serious
About Your
Profession



Being a certified electronics technician lets people know that you are a professional in your field. It tells them that you are serious about your work and can perform up to CET standards.

Now you can order the "Study Guide for the Associate-Level CET Test" from the International Society of Certified Electronics Technicians. It includes material covering the most often missed questions on the Associate CET exam. 8 1/2" x 11", paperback, 60 pages.

For More Information Contact:

IS CET, 2708 W. Berry, Fort Worth, TX
76109; (817) 921-9101

NAME _____

ADDRESS _____

CITY _____ STATE _____

ZIP _____

_____ copies @ \$5 (+ \$1 postage.)

_____ send material about IS CET
and becoming certified.

Products (continued from page 65).

screwdriver set, a flat knife case opener, a spring bar tool, pliers, two tweezers, a protection cloth, a 1988 Interchangeability Guide, a battery sizer and a magnifier.

Circle (92) on Reply Card

Hand lotion for technicians

Electro Lotion from *Start Manufacturing* is a hand and body lotion formulated for the electronics servicer. The lotion is non-contaminating and non-tarnishing to materials being processed and will not hamper the solderability of printed circuits or components. The lotion is water- and solvent-soluble and contains no lanolins, mineral oils or silicones.

Circle (93) on Reply Card

ESD grounding system

The Stat-Gard ESD grounding system from *Ideal Industries* uses a grounding plug, wrist strap and lead set to continually drain static charges from the

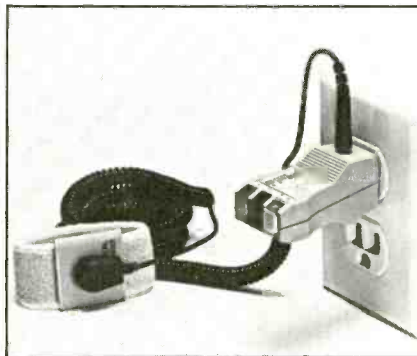

technician's body. The grounding plug inserts into any 3-prong, 120V receptacle and checks the 3-wire circuitry for wiring faults.

Circle (94) on Reply Card

Facsimile cleaning kit

The FAX Cleaning Kit from *Perfect-Data* is a printhead cleaning solution that cleans the printhead in facsimile machines and dries immediately. The kit contains the cleaning solution, ten cleaning wands, canned air, a case and cabinet cleaner and 25 non-residual wipes.

Circle (95) on Reply Card

Wrist-strap tester

The model 250 wrist-strap tester from *Electro-Tech Systems* measures the electrical integrity of a wrist-strap grounding system. The tester has visual and

audible indicators, a fail-safe design with automatic self-check, and two switch-selectable upper limits. A 9V alkaline battery powers the unit.

Circle (96) on Reply Card

RF signal generator

B&K-Precision has introduced the model 2005 RF signal generator, which covers 100kHz to 150MHz in six fundamental bands, and to 450MHz on harmonics. The output may be AM-modulated by an internal 1kHz source or externally by any audio frequency. Features include step and variable fine-output attenuation to 40dB, variable AM modulation from zero to 100%, an auxiliary output for the internal 1kHz audio source and separate outputs for the RF connection and an external frequency counter.

Circle (97) on Reply Card

Logic analyzer

The ML4400 logic analyzer from *Arrium* has 400MHz timing (100MHz sync) and user-selectable input cards for simultaneous analysis of up to four 8-, 16- and 32-bit microprocessors. The analyzer accommodates up to four standard or high-speed capture modules. The high-speed module has transitional timing and a memory depth of 8,192 to 32,667 cycles. Non-volatile memory and mono and color video outputs are standard.

Circle (98) on Reply Card

Static-dissipative field-service kit

Simco's static dissipative field service kit is a 24"x24" static-dissipative grounded work surface mat and a conductive wrist strap. The mat has two 11"x11" pockets for storing static-sensitive boards during transportation.

Circle (99) on Reply Card

Solvent sprayer

The Solvent Miser trigger-grip remote sprayer from *Micro Care Chemical Corp.* minimizes ESD damage when used with the company's MCC-ESD bench-top cleaning system for printed circuit boards and electronic assemblies. The 100% conductive sprayer, which also reduces solvent consumption, carries pictograms that illustrate proper assembly and disassembly procedures.

Circle (100) on Reply Card

ES&T

Quiz answers

Questions are on page 10.

1. Beginner's all-purpose symbolic instruction code.
2. C. According to the Audio Cyclo-pedia published by Howard W. Sams, "attenuators may be fixed in value or they may be variable." The word pad is defined as "another name for attenuator."
3. 12dB. This question was easy if you knew that *connected in tandem* means *connected in series*.
4. A—A Hay bridge. The bridge circuits are shown in Figure C. The Maxwell bridge is easy to construct, and with a little care you can get a reasonably accurate method of measuring inductance. A Schering bridge measures capacity using a high voltage. A Wein bridge measures frequency.
5. In a constant-k filter, the product of the series impedance (Z_1) and the shunt impedance (Z_2) is a constant

value for all input frequencies, so

$$Z_1 Z_2 = k^2 \text{ or}$$

$$k = \sqrt{Z_1 Z_2}$$

6. A—a differentiating circuit. The circuit is also a pre-emphasis circuit used in FM transmitters.
7. A—at the top. Using conventional current flow, grasp the coil (mentally) with your right hand so that your fingers circle the coil in the direction of current flow. Your thumb will then point to the north pole.
8. Control. The control signal regulates the speed of the tape through the VCR tape path.
9. 2.4V and 0.8V. These are the generally accepted voltage limits for TTL logic.
10. Digital storage oscilloscope. This type of oscilloscope was discussed in detail in the June 1988 issue.

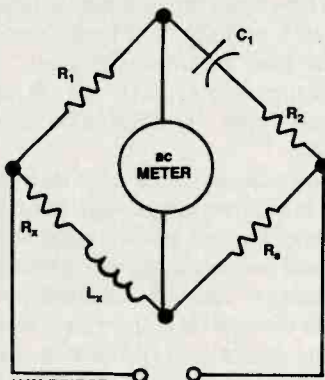

HAY BRIDGE

$$L_x = (R_1 R_2 C_1) / (1 + R_2^2 \omega^2 C_1^2)$$

$$R_x = (R_1 R_2 R_3) / (1 + R_2^2 \omega^2 C_1^2)$$

FIGURE C

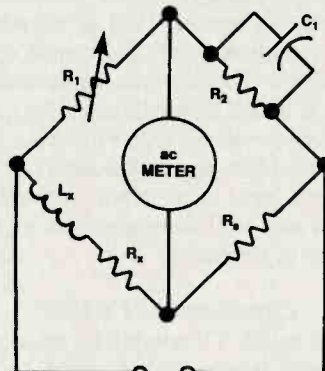

MAXWELL BRIDGE

$$L_x = R_1 R_2 C_1$$

$$R_x = (R_1 / R_2) R_3$$

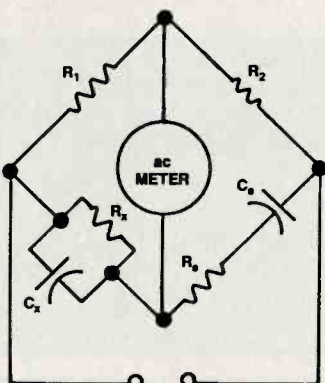

WEIN BRIDGE

$$f = 1 / (2\pi R_x C_x)$$

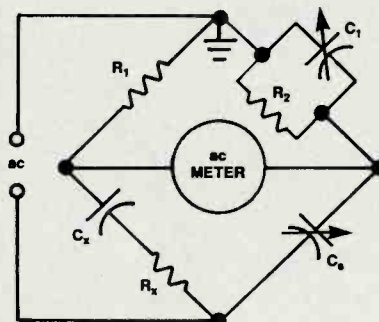

SCHERING BRIDGE

$$C_x = (C_2 / R_1) R_2$$

ORIGINAL PARTS

Why order your parts from several parts houses? Order them from your all-in-one parts distributor.



TRITRONICS

1306 Continental Drive
Abingdon, MD 21009-2334

PARTS ORDER DESK ONLY:

1-800-638-3328

Research and information:

1-301-676-7300

AUTHORIZED PARTS
DISTRIBUTOR FOR:

SHARP

SANYO

FISHER

RCA

PANASONIC

QUASAR

GE

TECHNICS

ALSO STOCKING

Large inventory of N.A.P. Parts
Sylvania • Philco • Magnavox

SAMS • CHEMTRONICS • RCA SK's

TRITRONICS

Circle (27) on Reply Card

Elements of video optics—Part II

By Carl Bentz

This material was adapted from "Elements of TV Optics," published in *Broadcast Engineering*, August 1986. Information for this article was provided by Angenieux, Canon, Fujinon, Schneider and Tamron.

Optical systems for TV cameras consist of combinations of lenses and prisms. The optical system concentrates light from a scene, separates it into red, green and blue components, and focuses the three color images on the light-sensitive faceplates of the pickup devices. The shapes, placements and specific glasses in optical elements of the camera all play a role in making this possible.

The index of refraction

As light passes through a medium, a characteristic *index of refraction* can be determined for that material. The index is a ratio between the speeds of light in free space and in the material. Unless a specific wavelength is stated, the index is determined from the primary wavelength (589m μ) of a yellow sodium flame.

The index for air at standard conditions (temperature of 20°C and barometric pressure of 760mm of mer-

cury) is often stated as *unity* (1) for simplicity, but that simplification is far from true. Violet (436m μ) and red (656m μ) lights produce indices of 1.0002957 and 1.0002914, respectively. The difference, although it may appear to be small, is sufficient that astronomers must make corrections in star-position calculations. Their job is more complex because the refractive index of air varies with the depth and density of the atmosphere.

The red-to-violet variance in the index for a medium (the *dispersion*) explains how an equilateral prism breaks white light into a rainbow spectrum. Each wavelength is affected linearly. For less energetic light of longer wavelengths, less bending occurs. (See Figure 1.)

As light passes from one medium to another, the rays are bent or refracted. The amount of bending depends upon the refractive index of the media and the angle at which light falls upon the junction between them. (See Figure 2.) The thickness of the second medium (for example, a lens) through which the light passes also will determine the overall change in direction.

Components of a lens

A complex TV zoom lens must pass the wide bandwidth of visible white light, bending it as necessary to form

an image on the pickup devices. Ideally, all elements in the lens will provide frequency-independent refraction of the light. Any deviation (dispersion) causes *chromatic aberration*. In TV optics, a result is an undesirable separation of colors, which appears as fringes around objects. (See Figure 3.)

The greater the bending power of the lens (that is, the greater the surface curvature), the greater the effect dispersion will have on the image formed by the lens. This fact creates a problem in the manufacture of high-magnification lenses.

A simple convex lens (see Figure 4) has two focal lengths. One (F) is the distance from the lens to the image for which an object exists at infinity (as in a camera). F' is the distance from the lens to the object for an image at infinity (as in a projector). If both faces of the lens have the same curvature, the two distances are equal (F=F'=f), and the lens may be oriented either direction.

If the entire diameter of a lens disk is used to form an image, light refracted near the edges may not converge at the same focal point as light passing through the center. A resulting distortion is a variance of magnification with distance from the center axis of the lens. (See Figure 5.) The image appears sharp, with pincushion or barrel distortion showing in lines removed from its center.

Bentz is the TV technical editor for *Broadcast Engineering*.

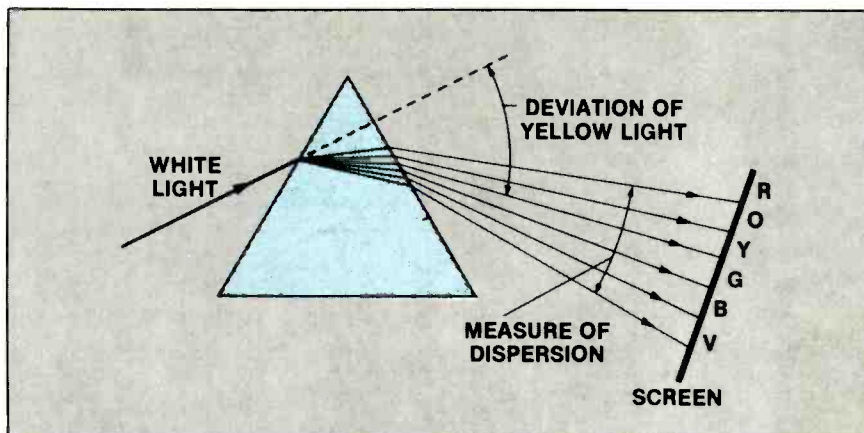

Figure 1. A prism may be used to break light into component colors because the index of refraction varies somewhat for each color's frequency.

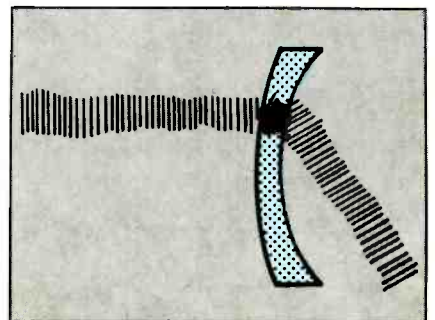

Figure 2. The amount of bending as the light ray enters the lens is determined by the index of refraction of the air and glass. As the ray passes back into air, it is bent again.

Our guaranteed savings plan.

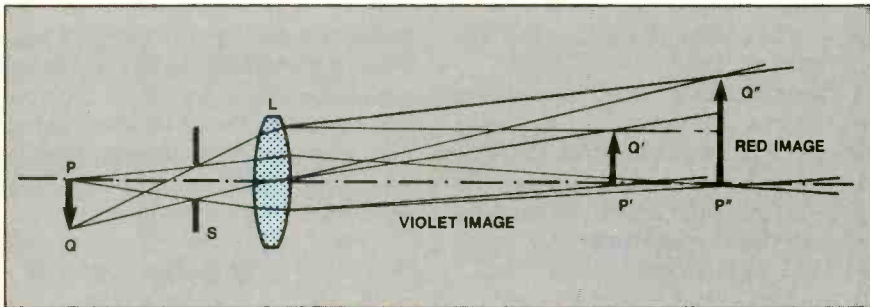
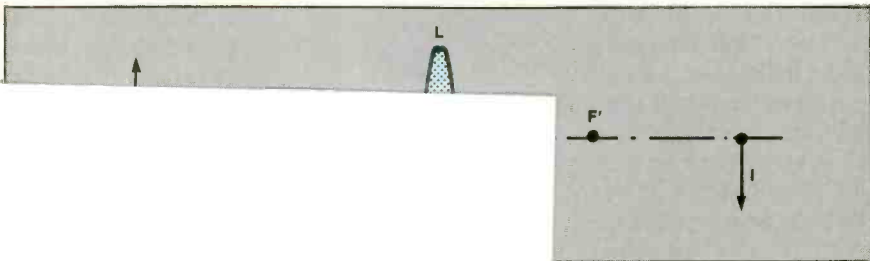

Figure 3. Different refractive indices can result in various colors focusing at different points.



Two focal points. In the TV camera, important. Between the lens and

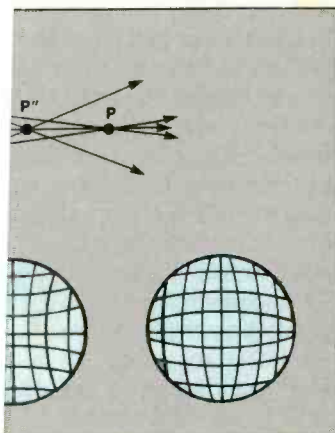
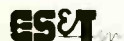

Figure 5. Pincushion and barrel distortion occur because of incorrect focusing through areas of the lens near the edges.

Convex lenses cause light rays to converge or meet at a focal point; concave lenses cause the rays to spread or diverge. Combinations of convex and concave shapes with each other and with flat or plane surfaces may be used to

correct optical distortions.

Next month, Video Corner will continue the "Elements of Video Optics" series with a discussion of apertures and f/stops.



Fluke 70 Series Analog/Digital multimeters are like money in the bank. Buy one, and you're guaranteed to save both time and money.

Money, because you get longer battery life and longer warranty coverage — 3 years vs. 1 year or less on others.

And time, because 70 Series meters are easier to operate and have more automatic measurement features.

Now Tool Kit Specialists, Inc., your stocking distributor for Fluke, is offering a chance to save even more.

Take a close look at our special prices effective until September 30, 1988.

FLUKE 73	FLUKE 75	FLUKE 77
\$89	\$104	\$130
Analog/digital display	Analog/digital display	Analog digital display
Volts, ohms, 10A, diode test	Volts, ohms, 10A, mA, diode test	Volts, ohms, 10A, mA diode test
Autorange	Audible continuity	Audible continuity
0.7% basic dc accuracy	Autorange/range hold	"Touch Hold" function
2000+ hour battery life	0.5% basic dc accuracy	Autorange/range hold
3-year warranty	2000+ hour battery life	0.3% basic dc accuracy
	3-year warranty	2000+ hour battery life
		3-year warranty
		Multipurpose holster

*Patent Pending



Call today for immediate delivery.

(408) 745-6020 or

(800) 621-0854 Ext. 202

Circle (28) on Reply Card

More about decibels

By Conrad Persson

The concept of the decibel is so crucial to dealing easily with electronics and audio that we're going to be talking about it here in some detail. (For more about decibels, see "Audio Corner" in the July 1988 issue.)

Let's take a look again at the definition of the decibel:

$$\text{dB} = 10 \log P_{\text{out}}/P_{\text{in}}$$

Okay, I agree, it looks like a pretty dumb concept. Why wasn't the decibel defined as just $\log P_{\text{out}}/P_{\text{in}}$? Or for that matter, do we really need to use decibels at all?

The key to understanding decibels is to recognize that, just as it is the case with a lot of other mathematics, the decibel was invented, made up out of whole cloth, just to make understanding and calculation of certain phenomena easier. The problem is that, although it makes things easier for the mathematician and the physicist, it makes things more confusing for the rest of us. However, if we spend a little time getting used to the idea, maybe some of the confusion will dissipate and we'll begin to see the usefulness of the concept.

Why use decibels anyway?

The sound of a jet engine is so loud that it creates not only the sensation of sound, but the sensation of pain as well.

The ratio of such a loud sound to the softest sound that the human ear can detect is one trillion to one. (See the table in the July Audio Corner for more decibel readings.) That's a lot of zeros.

Persson is editor of ES&T.

And that's one of the reasons why decibels are used.

Using decibels, that ratio can be represented by saying that the sound level of a jet engine is 120dB above the level of a barely discernible sound. The unit just gives the technician, engineer or scientist an easier way of handling numbers.

Another reason that decibels are used is that the user can add gains and subtract losses instead of multiplying and dividing.

Part of the confusion about the concept is simply that methods of mathematical prestidigitation such as logs and decibels are presented in texts and courses in line with the rest of the technical material, and the student or reader gets the impression that those things are an essential part of the technology when they actually have nothing to do with the technology. Let's face it, magazines do the same thing, too, also with no intent to confuse—it just happens.

It seems, therefore, as though the concept of the decibel is part and parcel of the electronics technology, as much as $E=IR$. It's not. The decibel is a mathematical construct that just happens to make it easier to handle certain aspects of math in conjunction with electronics.

An analogy (I leave it to you to comment on how apt it is) is that you can get from your house to the store in any of a number of ways, walking being the most basic. But you probably drive a car because it's easier—that is, once you go through all the trouble of learning to drive, getting a license, buying a car and getting it in-

sured, inspected and licensed. After a while it seems that the car is part and parcel of getting to the store, but it's not. You could still get to the store without the car, even if cars had never been invented. It's kind of like that with decibels.

It's all a matter of relativity

Now that we've beat that thought to death, let's talk about some of the other things that are done with decibels. To go back to the definition, a decibel expresses a ratio. If one sound, S_2 , is twice as loud as another, S_1 , then their ratio, expressed in this mathematical fiction, decibels, is:

10dB

$$\begin{aligned} \text{dB} &= 10 \log S_1/S_2 \\ &= 10 \log 2 \\ &= 10(0.30103) \\ &= 3 \end{aligned}$$

So if one sound is twice as loud as another, it is about 3dB greater. That gives us some good information, but it's still relative. To know the loudness of sound S_2 , we need to know how loud sound S_1 is and vice versa. The same bright guys who gave us decibels came

120dB



up with a way to express decibel ratios so you know exactly the reference level and, therefore, the value of the phenomenon of interest.



50dB

For example, a commonly used reference level in the telephone industry is 1mW. The abbreviation for the ratio of the power level of signals either above or below 1mW is dBm. Thus, a signal described as being at 9dBm would be approximately at 8mW. A simple, rough way to arrive at that number is to figure that for each 3dB the power approximately doubles, so at 9dBm, the signal is about $((1\text{mW} \times 2) \times 2) \times 2$, or approximately 8mW.

40dB



Here are a few other commonly used decibel gain expressions referred to specific levels:

dBj—1mV
dBk—1kW
dBw—1W

There are books of tables (for example, *The Handbook of Electronic Tables and Formulas, Fifth Edition*, compiled and published by Howard W. Sams) that include tables of equivalences between decibels and ratios. If you're stymied by log tables and you're faced with a decibel problem a little tougher than the nice, round 9dBm that I chose, you can still convert.

As an example, taking two rows from the table in the Sams book, 1dB converts to a numerical gain ratio of 1.259, and 2dB converts to a numerical gain ratio

of 1.585. So let's say that in the example above, the power had been 10dBm instead of 9dBm. The signal of interest would then have been approximately $((1\text{mW} \times 2) \times 2) \times 2 \times 1.259$ or 10.1. In other words, for each 3dB gain, double the reference number. Do that three times and there's 1dB left over, which represents another 1.259 times the total.

Working with decibels can be confusing and frustrating, but with a little reflection to get them into perspective, you can feel comfortable with the concept.

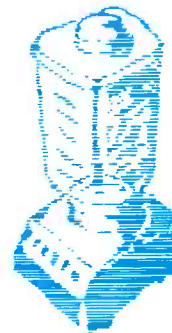

100dB

ES&T



National Electronics Sales & Service Dealers Association
NESDA
Service Dealers Association

Plug in!

To the NESDA system.

YOUR BUSINESS is in the world's fastest changing industry. If you're not careful, you could find your business in the dark.

But, you don't have to stay there.

Through a system of local, state, and regional groups, the National Electronics Sales & Service Dealers Assn. (NESDA) keeps members up-to-date with the fast pace of advancing technology while offering:

- ◆ Managerial and technical training.
- ◆ Business contacts.
- ◆ Technical and management certification.
- ◆ Information on new products.
- ◆ Legislative activities that affect the industry.

Don't be left in the dark. Let the NESDA system work **FOR YOU!**

For more information and an application, write to:
 NESDA, 2708 W. Berry St., Ft. Worth, TX 76109; Ph (817) 921-9061

Name _____

Bus. Name _____

Address _____

State _____ Zip _____ Phone _____

Member of State Local Assn. _____

The writing's on the wall ...

VCR PARTS SEMICONDUCTORS CHEMICALS
 SPEAKERS AND ACCESSORIES TEST EQUIPMENT
 FRIENDLY SERVICE CONVENIENT HOURS
 COMPETITIVE PRICES QUICK DELIVERY
 SOLDERING EQUIPMENT

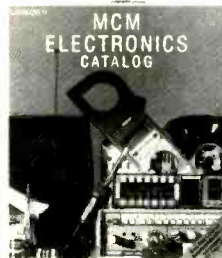

MCM has all your electronic part needs!

For your **FREE** copy, call **TOLL-FREE! 1-800-543-4330**
 In Ohio, call 1-800-762-4315
 In Alaska or Hawaii, call 1-800-858-1849



MCM ELECTRONICS
 858 E. CONGRESS PARK DR.
 CENTERVILLE, OH 45459-4072
 A PREMIER Company

ES-37

Circle (29) on Reply Card

Interfacing computers to the analog world—Part IV

By Joseph J. Carr, CET

The first few parts in this series have described analog-to-digital (A/D) and digital-to-analog (D/A) converters. Last month we looked at two techniques for performing an A/D conversion: single- and dual-slope integrators. This month we'll cover counters (or servos) and successive approximation methods.

Counter-type A/D converters

A counter-type A/D converter (also called a *servo* or *ramp* A/D converter) consists of a comparator, a voltage-output D/A converter (DAC) binary counter and the necessary control logic. (See Figure 1.) When the start command is received, the control logic resets the

binary counter to 00000000, enables the clock and begins counting.

The counter outputs control the DAC inputs, so the DAC output voltage will begin to rise when the counter begins to increment. As long as analog input voltage V_{in} is less than V_{ref} , the DAC and comparator outputs are HIGH. When V_{in} and V_{ref} are equal, however, the comparator output goes LOW, which turns off the clock and stops the counter. The digital word appearing on the counter output at this time represents the value of V_{in} .

Both slope and counter-type A/D converters take too long for many applications—about 2^N clock cycles (where N equals the number of bits). Conversion times become critical if the high-frequency component of the input

waveform is to be faithfully reproduced. The sampling rate (that is, conversions per second) must be at least twice the highest frequency to be recognized.

Successive approximation A/D converters

Successive approximation A/D converters are best suited to applications where speed is important. This type of converter requires only $N+1$ clock cycles to make the conversion, and some designs allow truncation of the conversion process after fewer cycles if the final value is found prior to $N+1$ cycles.

The successive approximation converter operates by making several successive trials comparing the analog input voltage with a reference generated by a DAC. An example is shown in

Carr, an electronics engineer, has published several books on electronics and is a frequent contributor to ES&T.

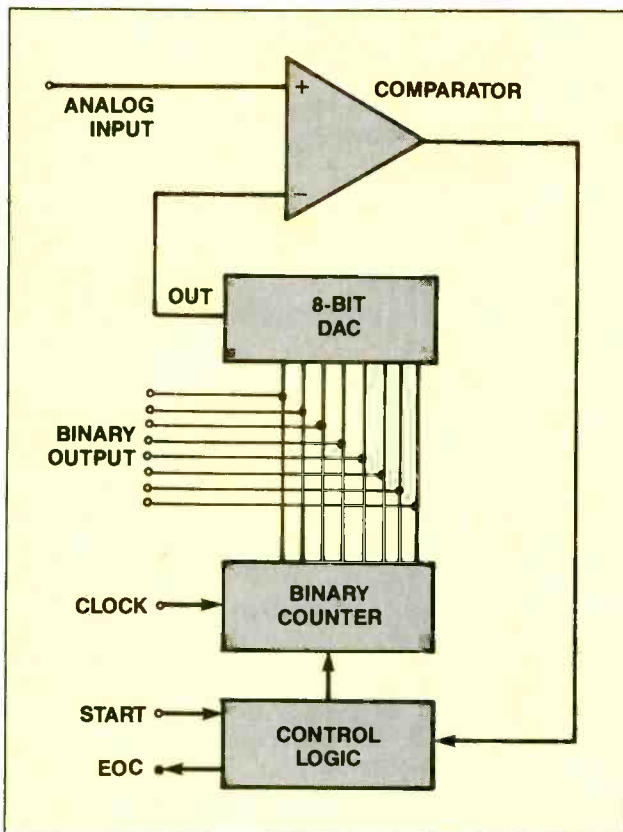

Figure 1. A counter-type A/D converter consists of a comparator, a voltage-output DAC binary counter and the necessary control logic. When the start command is received, the control logic resets the binary counter to 00000000, enables the clock and begins counting.

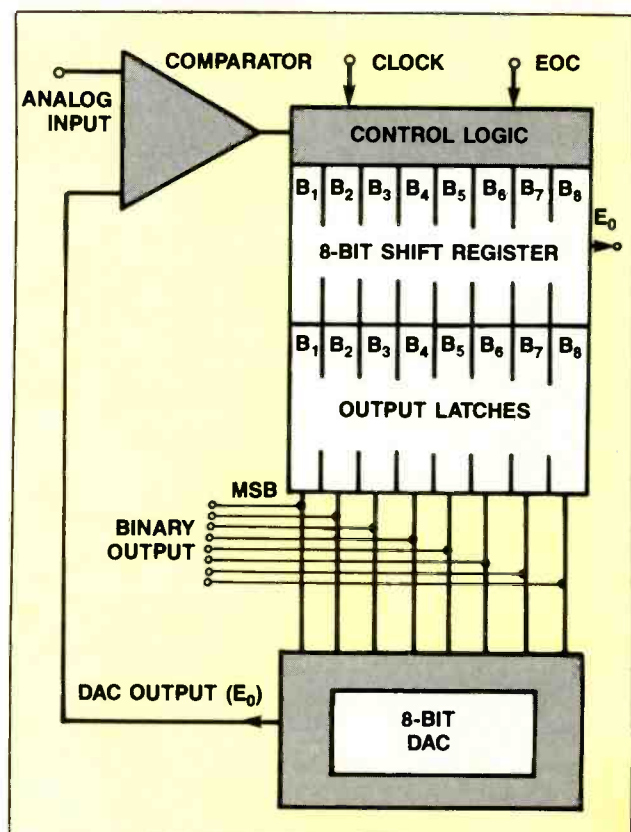

Figure 2. The successive approximation converter makes several successive trials comparing the analog input voltage with a reference generated by a DAC. This circuit consists of a comparator, a control logic section, a shift register, output latches and a DAC.

Figure 2. This circuit consists of a comparator, a control logic section, a shift register, output latches and a voltage output DAC.

When a start command is received, a HIGH is loaded into the most significant bit (MSB) of the shift register, which sets the output of the MSB latch HIGH. A HIGH in the MSB of a DAC will set the output voltage (V_{ref}) to half-scale. If the input voltage (V_{in}) is greater than V_{ref} , the comparator output stays HIGH and the HIGH in the shift register MSB position moves one bit to the right to occupy the next MSB (bit 2). Again, the comparator compares V_{in} with V_{ref} . If the reference voltage from the DAC is still less than the analog input voltage, the process will be

repeated with successively fewer significant bits until either a voltage is found that is equal to V_{in} (in which case the comparator output drops LOW) or the shift register overflows.

If, on the other hand, the first trial with the MSB indicates that V_{in} is less than the half-scale value of V_{ref} , the circuit makes trials below V_{ref} . The MSB latch is reset to LOW and the HIGH in the MSB shift register position shifts one bit to the right to the next MSB (bit 2). The trial is repeated again. This process will continue as before until the correct level is found or overflow occurs. At the end of the last trial (bit 8 in this case), the shift register overflows and becomes an *end of conversion* (EOC) pulse to tell the rest of

the world that the conversion is complete.

This type and most other types of A/D converters require a starting pulse and signal completion with an EOC pulse. This requires the computer or other digital instrument to engage in bookkeeping to repeatedly send the start command and look for the EOC pulse. If the start input is tied to the EOC output, conversion is continuous and the computer need only look for the raising of the EOC flag.

Now that you understand how A/D and D/A converters work, we're ready to tackle some practical data converters. Next month we'll begin looking at popular A/D circuits.

ES&T

Technicians, Get Serious About Your Profession



Being an IS CET-Certified Electronics Technician lets the world know that you are serious about your profession. It announces that you are a studious professional who allowed yourself to be measured — and then measured up. It says that you can perform to the standards set by the International Society of Certified Electronics Technicians.

If you're serious about being the best technician you can be — and you want other people to know that you are, contact IS CET to set up an appointment to take the test. Or order the "Study Guide for the Associate-level CET Test." It's 60-pages of 8½" x 11" material which covers the most often-missed questions on the Associate CET exam.

For more information, contact:

IS CET, 2708 W. Berry, Ft. Worth TX 76109; Phone (817) 921-9101

Name _____

Address _____

City _____ State _____ Zip _____

Send ___ copies of study guide @ \$6 (includes postage).

Send more information about CET and IS CET.

Presenting an affordable Light Box System.

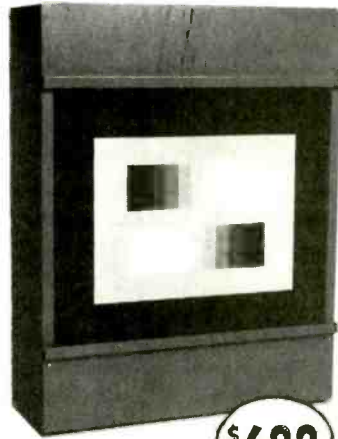

\$688

The method most manufacturers recommend

Model TR100 CB
Camera Light Box
with (2) transparencies

- (2) 3200° Kelvin Lamps (meets mfr. spec.)
- 1-year conditional guarantee
- Transparencies mounted in acrylic with optical scratch-resistant surface
- 11-step gray scale transparency
- 7-Bar color transparency
- All orders are shipped within 72 hours, U.P.S.

NUTRONIX (313) 939-2740



P.O. Box 77103 • Sterling Hts., MI 48077



Circle (30) on Reply Card

Readers' Exchange

Editor's Note: Readers' Exchange items are published in the order they are received. We are happy to offer this service at no charge to you, our readers, but we ask that:

- Items are typed (or legibly written).
- You include your name and address on the same page as your ad (envelopes and contents are often separated). Please also include your telephone number (specify if you don't want it published). Using your peel-off label is a good idea.
- You limit any ad to no more than three items. If space demands, ads will be edited to roughly four lines in the magazine.
- Mail to: Readers' Exchange, Electronic Servicing & Technology, P.O. Box 12901, Overland Park, KS 66212.

Please remember that **ES&T** is in production six weeks to two months *ahead* of publication date.

WANTED

Power transformer for a Sylvania D-12 chassis, part number 55-27416-2. Prefer new, but will consider used. *Robinson Electronics, 525 Airport Road, Santa Fe, NM 87501; 505-471-7892.*

CRT 520SB22A for Sony model KV1952R TV; Sencore VA48 for \$500, must be in excellent condition. *James D. Lokken, 18402 Avolinda, Yorba Linda, CA 92686; 714-777-2345.*

Schematic diagram and service manual for Sound Creation AM/FM/cassette auto radio (FCC ID: BMM883SCR901), made in Korea. Will pay for copy of literature. Would also appreciate mailing address for the USA office of this company. *H. Fuqua, 1423 Jordan Drive S., Salem, OR 97302; 503-399-1423.*

Schematic or service manual for Hallicrafters models S-40 and S-40B radios. Photocopy will do. Will pay. *RAM TV Service, San Vicente 4E, Mayaguez, PR 00708.*

Jukebox service manuals and parts, particularly a mechanism cover for a Seeburg HF-100G, a high-frequency horn for an AMI model F-120 and a manual for a Seeburg model AY-160. Also need a service manual for any Scopitone machines. *Mike Zuccaro, Voice & Video, 5038 Ruffner St., San Diego, CA 92111; 619-560-1166 days, 619-271-8294 evenings and weekends.*

Power xfmr for a B&K #1076, part number 065-007-9-001. *Koleske TV Sales and Service, 1124 N. Mason St., Appleton, WI 54914; 414-734-5340.*

Zenith deflection yoke, part number 95-3357, for a model S1984W6, chassis 19KC542. Zenith no longer makes this part. Could use two. Please state price and condition. *Hawaiian TV, 1250 S. King St., Honolulu, HI 96814; 808-521-3838.*

Schematic, layout and alignment info for a Eico 2536 stereo receiver; operators and service info for a Precision Apparatus tube tester, series 10-54, Test Master; power transformer for a McIntosh

MI-3 stereo indicator. Will pay any costs. *Randy Garbiel, 1955 McEachern Manor Drive, Marietta, GA 30064; 404-424-9962.*

Flyback transformer (part number RTRNF1214CEZZ) for a Sharp model 19F72 19-inch color TV; schematic for an RCA model BWT122W B&W portable TV. *John Brouzakis, 247 Valley Circle, Charlerol, PA 15022; 412-483-3072.*

Service information and schematic for a VARO model FL-3D flutter meter; Hammarlund HQ-180 receiver. *William Zukowski, 12 Lark Place, Old Bridge, NJ 08857; 201-679-4749.*

Fluke model 77 or 23 multimeter; Heathkit model 5283 signal tracer; service manual for a Hitachi model V422 oscilloscope. *George John Demaris, 7387 Pershing Ave., Orlando, FL 32822-5743; 407-277-3746.*

For J.C. Penney color TV, model 685-2012, chassis number NMPX3A (tripler part number: ECX-B0083). State price. *Joe LaGuardia, 1521 Flamingo Court, Homestead, FL 33035; 305-257-7841.*

Deflection yoke for an Emerson model ECT1900 color TV. The number of the yoke is KY10030SD11. Please send price. *Augustine's TV • Radio Service, 530 N. Ninth St., Reading, PA 19604; 215-372-5438.*

Diagram for an RCA model RE-45 radio; a horizontal output transformer for a Sears model 564-416-92-804—I don't have the part number; a Simpson 260 voltmeter. *Ralph Dorough, 117 Pecan St., Terrell, TX 75160; 214-563-7105.*

Schematic and operators manual for a Robyn model 2000B Hi-Low Bander FM scanning receiver. *Don Wells, Kewaunee Engineering Corp., N. Main St., Kewaunee, WI 54216.*

Heathkit TTL/CMOS circuit course. Will pay the original price. *Ron Grega, 107 Ridgeview Drive, Dunmore, PA 18512; 717-347-6842.*

I have purchased a set of RCA home-study courses dated 1966-1967. I'm trying to learn radio and TV servicing in the course, and in between books 1011E and 1015E, the student built a test oscillator and radio and used them to get practical experience. If you have the items and would like to sell, please write. *E.A. Jenkinson, 1415 Poplar, Pine Bluff, AR 71601.*

Late TV servicing course by NRI, etc.; Sencore or B&K test instruments, for example, an adjustable ac isolated power supply, an FM signal generator, etc. *Ed Herbert, 410 N. Third St., Minersville, PA 17954.*

FOR SALE

Eico 460 oscilloscope, \$40; Dupont 3-inch oscil-

loscope, \$20; Dupont battery frequency meter, \$20; 45 record player, \$30; antique oak wall S.C. telephone, \$200. Add UPS charges. *Clark Trissell, 3530 Pawnee St., Lincoln, NE 68506; 402-488-5263.*

Simpson Electric model 467 DMM, measures up to 1,000Vdc, 750Vac, 2A ac-dc, 20M Ω , includes leads and manuals, \$100; Dumont model 1062 oscilloscope, 50MHz bandpass, dual vertical inputs, main and delay sweeps, 100% solid state, \$495; Deihl model MARK III scanner, new, turn on any shut-down TV, \$250. Add \$10 for insured UPS shipping; COD is OK, too. *Fred Jones, 407 Morningbird Court, Niceville, FL 32578; 904-678-1803.*

Sencore LC75 Z meter capacitor and inductor analyzer, like new, original packaging, \$595 or will trade for a Sencore SG165 AM/FM stereo analyzer. *Jim Patrick, 69 Main St., Greenwich, NY 12834; 518-692-9366 days, 518-692-2855 evenings.*

Heath IO-101 vector scope/color dot bar generator, \$75; Heath RCL bridge, \$50; Diehl Supertech MKIV, \$350; 25A isolation xfomer, \$200 (new). *Cahill Electronics, P.O. Box 568, Kingston, NH 03848; 603-642-4292.*

Heathkit ET-3100 Design Console, \$120; CIE single-trace, 10MHz oscilloscope, \$150. Both in excellent condition. *J. Kostalek, 3141 Lodwick Drive, Warren, OH 44485.*

Two Ampex VR-660B 2-inch video recorders with many spare parts; two Sony CLR-1 color decoders. These pieces of equipment are located on Long Island, NY. *Robert Carlough, 8122A Thames Blvd., Boca Raton, FL 33433; 407-488-3467.*

Sencore CRT rejuvenator testers: model CR161, \$85; model CR143, \$50. Both in excellent shape. Add shipping. *James D. Lokken, 18402 Avolinda, Yorba Linda, CA 92686; 714-777-2345.*

Assorted Sams sets, #1 to #2000, \$4 each, includes postage. Send SASE and \$4 for each set you want. *Gordon F. Williams, P.O. Box 578, Arlington, GA 31713.*

McMurdo-Sliver model 15-17 radio, 15 tubes, 4-band, push-pull 6L6 output with a 15-inch Jensen Electro Dynamic speaker, chromium-plated chassis, tube and coil shields. Perfect working order. Chassis and speaker only—no cabinet. Best offer. Also for sale: new tubes at 90% off list price; text books; service manuals; magazines—send large SASE for list. *M. Seligsohn, 1455 55th St., Brooklyn, NY 11219.*

TSM #24-159—all for \$125, shipping included. *Koleske TV Sales and Service, 1124 N. Mason St., Appleton, WI 54914; 414-734-5340.*

New, used only once Philips ECG model FET-43 analog meter—10MHz, 2-input, includes warranty card and instruction booklet, \$35 plus shipping. *Stanley Todorow, G8468 Belle Bluff Drive, Grand Blanc, MI 48439; 313-695-0271.*

Sencore CR-143, like new, \$150; Sencore TRC4, like new, \$40; HP universal bridge, \$150; B&K model 606 tube tester, \$75. *Harley W. Jansen, 1600 First Ave., Marion, IA 52302; 319-377-3141.*

Sencore equipment: 1-year old, like new, SC-61, VA-62, VC-63, NT-64, EX-231, \$5,250; SG-165, \$895. *Angelo Russo, Tes Marketing, 3800 Lucius Road, Columbia, SC 29201; 800-553-5332.*

Heathkit model 3100B circuit trainer; "Concepts of Electronics" course with 2-binder set and parts—\$110 for both. *Ron Grega, 107 Ridgeview Drive, Dunmore, PA 18512; 717-347-6842.*

Cushman CE-5 w/302, 313 and 314; Helper Sinader S101; B&K 80MHz multifunction counter. *Perry Nolan, 1509 N. Lorraine, Hutchinson, KS 67501; 316-663-4748.*

Set of GE manuals for GE business band radios, \$275; Johnson Radio LTR system select kit, \$15. Add shipping. *Fred Allen 327 Polk St., Grand Forks, ND 58201; 701-746-0073.*

Sony model 0005-18 SQ-checker, \$50; RCA model

WR-99A crystal-calibrated marker generator, \$50; Tohnichi torque gauges, 0 to 2mm/kg, \$20; Sony torque gauges—SL-0004 measures 0 to 1,200g/cm, SL-0003-C measures 0 to 150g/cm, \$20 each or both for \$35. All works. Add postage. *J. Cruz, Box 3974, Langley Park, MD 20787.*

Sams sets, #11 through #2515, all offers considered; Sencore equipment: SG165, \$500; PR57, \$300; UPS164, \$200. All like new, in original cartons, with manuals. *Leo B. Heinz, Heinz Radio and TV Service, 730 N. 81st St., Lincoln, NE 68505.*

Three Heathkit courses: electronic communications, semiconductor and electronic test equipment, all with parts and trainer, never used, \$250; Beckman model DM45 digital VOM, \$60; B&K model 2845 digital VOM with manuals and leads, brand new condition, \$40. *Daniel Seidler, 3721 W. 80th St., Chicago, IL 60652; 312-284-8221.*

Sams Photofacts from #1010 to #2382. Folders below #1500, \$2.50 each; between #1500 and #1999, \$3.50 each; above #1999, \$4 each. Also for sale, Sams VCR manuals #1 to #46, \$7 each. Send SASE for updated list of items still available. *T.*

Conde, 513 Troy St., Dayton, OH 45404; 513-461-0451.

Sencore VA48 video analyzer, \$550/offer; Diehl Mark V scanner, new, \$395/offer; Diehl Mark III scanner, New, \$195/offer. *Duane Conger, 4321 Herrick Lane, Madison, WI 53711; 608-238-4629.*

B&K model 510 transistor and SCR tester, \$65; Sencore sweep circuit analyzer, \$65; Grundig 9-band short-wave radio, solid-state, \$70. *F. Lurry, 4924 69th St., San Diego, CA 92115; 619-462-7445.*

RCA tuner modules, \$15 to \$30. Send SASE for info. *M.E. Andrews Jr., P.O. Box 91, Exeter, RI 02822.*

Radio Electronics magazines: Nov.-Dec. 1972, Jan. through Oct. 1973, Feb. through Dec. 1984, Jan. through March 1985—\$0.25 each or all 25 magazines for \$5; Popular Electronics magazines: May 1960 through April 1978—\$0.25 each or all 48 magazines for \$10. Add shipping. *John Brouzakis, 247 Valley Circle, Charleroi, PA 15022; 412-483-3072.*

ES&T

Classified

Advertising rates in the Classified Section are \$1.55 per word, each insertion, and must be accompanied by payment to insure publication.

Each initial or abbreviation counts as a full word.

Minimum classified charge \$30.00.

For ads on which replies are sent to us for forwarding (blind ads), there is an additional charge of \$35.00 per insertion to cover department number, processing of replies, and mailing costs.

Classified columns are not open to advertising of any products regularly produced by manufacturers unless used and no longer owned by the manufacturer of distributor.

FOR SALE

TV TOUGH DOGS: 300 symptoms and cures. Send \$7.95 to DAVIS TV, 11772 Old Fashion Way, Garden Grove, CA 92640. 10-87-tfn

TV/VCR REPAIR TIPS—Over 1,000 up-to-date problems/cures listed by model and chassis for quick easy lookup. A great reference for just \$29.95. Add \$2.50 postage and handling. Computer Assistance, Box 232026, Anchorage, AK 99523. 8-88-3t

AAA ELECTRONICS: Parts NTE, chemicals, supplies. For flyer write to 2336 S. Presa, San Antonio, Texas 78210, or call 1-800-444-6330. 9-88-2t

SONY-TRINITRON Rebuilt Picture Tubes are now available. All tubes shipped U.P.S. No Charge. We buy all Sony duds. Rochester Kinescope, 716-235-0750. 11-87-tfn

TV/VCR "Tuff Tips" listed by mfg. and model. 1st or second edition, 200 tips per edition, \$10.95, both editions \$19.95. TV Tips only, 1st or 2nd edition \$5.95, both editions \$10.95. VCR Tips only, 1st or 2nd edition, \$6.95, both editions \$12.95. TECH CURES, 4825 Fredericksburg Road, San Antonio, Texas 78229. 6-88-tfn

TV/VCR Failure Histories—Multiple cures for most problem areas. Send \$6.95 with mfg. and model number to TECH CURES, 4825 Fredericksburg Road, San Antonio, Texas 78229. Money will be refunded with free sample, if model is not on database. 6-88-tfn

VCR CROSS-REFERENCE listing for the following electronically-similar manufacturers: RCA, GE, Sylvania, Panasonic, Quasar, Magnavox, Philco, and J.C. Penney. Send \$13.95 to TECH CURES, 4825 Fredericksburg Road, San Antonio, Texas 78229. 6-88-tfn

O'SCOPE. TEKTRONIX. 465 100MHZ \$1000. Tektronix. 475 200MHZ \$1600. HP1740A. 100MHZ \$1000. Much more equipment available. Cal-Scope, 473-707 Macara Ave., Sunnyvale, Ca. 94086. (408) 730-4573. 7-88-3t

VHS-VCR REPAIR SOLUTIONS VOLUMES I, II, III. Each contains 150 symptoms and cures, cross reference chart, free assistance. Each \$11.95, any two \$19.95, all \$29.95. Eagle Electronics, 52053 Locks Lane, Granger, IN 46530. 5-88-tfn

COMPUTER TV/VCR SERVICE TIPS DATABASE PROGRAM (IBM Compatible). Scan symptoms and cures in seconds by model or chassis. Add, change, delete, print out hard copy. An excellent aid for the technician. \$49.95 for program. \$69.95 includes up-to-date database with 1,000 plus ServiceTips. Add \$2.50 postage and handling. Computer Assistance, Box 232026, Anchorage, AK 99523. 8-88-3t

FOR SALE SENCORE TEST equipment. VCR test acc., pattern gen., video analyzer, manuals, probes, and accessories. \$3200.00. Call 614-947-2827 or 614-289-2565. 9-88-11

FOR SALE: Sencore VA62 analyzer with NTSC generator and VCR test adapter. Includes all probes and manuals. \$3,000 or best offer. Also, CR70 CRT tester, \$700. Both items are in excellent condition. Call (201) 382-7505 after 5 pm EDT. 9-88-11

PHOTOFACTS: Folders under #1400 \$4.00. Above #1400 \$6.00. Sent same day first-class postpaid. Loeb, 414 Chestnut Lane, East Meadow, NY, 11554. 9-88-3t

HELP WANTED

WORK IN TAX FREE CARIBBEAN Must be capable of repairing all major brands TV/VCR/camera and audio including CD. Satellite/Computer experience an advantage. Relevant certificates including experience mandatory. Good working conditions in well equipped shop. Send resume to: Manager, 660 SW 63 Court, Miami, Fla. 33144 or call 809-949-8255. 9-88-11

BUSINESS OPPORTUNITIES

GREAT BUSINESS OPPORTUNITY for those who enjoy winter sports, hunting, year round recreation in the beautiful Rocky Mountains. TV-VCR sales and repair business with twenty-four hundred sq. ft. building including latest Sencore equipment. Located in downtown Salida, Colorado. \$55,000 for all. 719-539-7571. 9-88-11

RIVERSIDE, CALIF. Established TV-VCR-Antenna Service company with \$80 to \$100K gross income. \$10,000 and you take over. (714) 684-4404. 9-88-2t

**PERSONALIZED 24-HOUR SERVICE
ON OVER 10,000 ELECTRONIC
COMPONENTS & PRODUCTS...**

CALL TOLL FREE

IN
1-800-558-9572 WIS 1-800-242-9553
24 HOUR ORDERING: FAX: 414/473-4727



PROJECTOR-RECORDER BELT CORP.
P.O. Box 176 • Whitewater, WI 53190
TLX 4994411 PRBUSA

Circle (33) on Reply Card

Tech's Guide To Pricing
updated new 5th edition... a framework for setting rates that apply to Hi-Tech products a formula that guarantees SUCCESS!
Call Toll Free for details
1-800-228-4338 8/5 CST

Circle (34) on Reply Card

HAND REMOTE REPAIR
LA GUARDIA ENT
5882 Rich Hill Way
Yorba Linda, CA 92686
(714) 579-1276

- Call for pricing
- 24 hr. turnaround time
- Return freight pre-paid

Circle (32) on Reply Card

MOVING?

If you're planning a move in the near future, don't risk missing an issue of Electronic Servicing & Technology. Please give us 6-8 weeks notice if you're planning on changing your address. Just write in your new address below and mail this coupon, WITH YOUR SUBSCRIPTION MAILING LABEL, to:

ELECTRONIC
Servicing & Technology

Subscriber Services
P. O. Box 12901
Overland Park, KS 66212

Name _____
Address _____
City _____
State _____ Zip _____

Ad Index/Hotline

Company	Page Number	Reader Service Number	Advertiser Hotline
American Reliance	18	10	800/654-9838
Amprobe Instruments	3	4	516/593-5600
Automated Production Equipment Corp.	33-34	41	516/654-1197
Beckman Industrial Corp.	1	1	619/495-3200
Best Power Technology Inc.	31-32	39	800/356-5794
C+S Sales	63	24	800/292-7711
Chemtronics, Inc.	1	3	800/645-5244
Com-Kyl Inc.	65	26	800/538-1578
Consolidated Electronics Inc.	62	23	800/543-3568
Consumer Electronics Show	19		
Contact East	66	25	800/225-5370
Cooper Group	55	19	919/362-7510
Dandy Mfg. Co.	76	31	800/331-9658
E-Z Hook	45-46	48	818/446-6175
ETA	62		
Fluke, John Mfg. Co., Inc.	5, 11	5, 8	800/227-3800
Fordham Radio Supply Co.	7	6	800/645-9518
Heath Co.	61		616/983-6004
Hitachi Sales Corp. of America	21	11	516/921-7200
IC Master	43-44	44	516/227-1300
ISCET	66		
Laguardia Enterprises	76	32	714/579-1276
Leader Instrument Corp.	33-34	40	800/645-5104
M.A.T. Electronics	59	21	800/628-1118
Matsushita Services Co. (Parts Div.)	12-13	9	
MCM Electronics	71	29	800/543-4330
NESDA	71, 73		
NRI Schools—Electronics Division	30A-30B		202/244-1600
NTE Electronics, Inc.	45-46	47	800/631-1250
Parts Express Int'l Inc.	57	20	513/222-0173
Philips ECG	27-14	15	800/225-8326
Projector Recorder Belt Corp.	76	33	800/558-9572
PTS Corp.	51	17	812/824-9331
Sencore, Inc.	IBC	2	800/843-3338
Simpson Electric Co.	17	35	312/697-2260
Specialized Products Co.	45-46	46	800-527-5018
Sperry Tech, Inc.	76	34	800/228-4338
TAB Books	31-32	38	800/233-1128
Tech Spray	30A-30B	36	800/858-4043
Techni-Tool	43-44	45	215/825-4990
Tektronix, Inc.	8-9, 8A-8B	7	800/835-9433
Tental	31-32	37	800/538-6894
Test Probes, Inc.	53	18	619/535-9292
Thomson Consumer Electronics	22-23	12	
Tool Kit Specialists, Inc.	69	28	800/621-0854
Tritronics	67	27	301/676-7300
Tronix, Inc.	73	30	313/939-4710
Tucker Electronics	33-34	42	800/527-4642
U.S. Instrument Rentals	25, 43-44	13, 43	800/824-2873
U-CAN-DO VCR Educational Products Co.	61	22	513/548-6113
Zenith	BAC, 30A-30B		

NEW LOW PRICE \$39.95

TEST & RESTORE EVERY CRT on the market... without ever buying another adaptor socket for your CRT tester. Fits ALL makes & models. MONEY BACK GUARANTEE. Over 12,000 sold. Complete Patented Kit, with Sockets & Setup Book... Only \$39.95 + \$2.50 P&H. A one-time investment for life! Visa/MC/COD's/Checks.

FREE CALL 1-800-331-9658
DANDY MFG. CO.
2323 Gibson Street Muskogee, OK 74403

Circle (31) on Reply Card

**Use ES&T
classified
ads**

ADVERTISING SALES OFFICES

ELECTRONIC
Servicing & Technology

KANSAS CITY, MISSOURI
Greg Garrison, Sales Manager
P.O. Box 12901
Overland Park, KS 66212
Phone: (913) 888-4664
Fax: (913) 888-7243
Telex: 42-4156 INTERTEC OLPK

OXFORD, ENGLAND
Nicholas McGeachin
Roseleigh House, New Street
Deddington, Oxford OX5 4SP
Phone: (0869) 38794
Telefax: (0869) 38040
Telex: 837469 BES G

TOKYO, JAPAN
Haruki Hirayama,
EMS, Inc.
Sagami Bldg., 4-2-21, Shinjuku,
Shinjuku-ku, Tokyo 160, Japan
(03) 350-5666
Telex: 2322520 EMSINCJ
Cable: EMSINCPERIOD

FREWVILLE, SOUTH AUSTRALIA
John Williamson
Hastwell, Williamson, Rep. Pty. Ltd.
109 Conyngham Street
Frewville 5063
South Australia
Phone: 799-522
FAX: 08 79 9735
Telex: AA87113 HANDM

With Just One Probe Hookup You Can Confidently Analyze Any Waveform To 100 MHz, 10 Times Faster, 10 Times More Accurately, Absolutely Error Free, Guaranteed Or Your Money Back . . .



**With The SC61 Waveform Analyzer
\$3,295.00 PATENTED**

Promises of increased productivity from other oscilloscopes fade fast when compared to the speed and accuracy of the SC61. Eliminate the confusing menus, cursors and complexity of regular oscilloscopes at the push of a button. Here's what the SC61 does for you:

Analyze Waveforms Easily

- Accurate Waveform Display - 60 MHz Bandwidth (useable To 100 MHz) To Test The Latest Digital Circuits.
- Rock-Solid Sync - ECL Logic Circuits And Differential Amplifiers Give Fiddle Free Operation.
- Four Times The Measuring Range - Measure From 5 mV To 2000 Volts (3000 Volts Protection) For Expanded Signal Handling.

Autotracking™ Digital Readings Analyze The Whole Signal

- Autoranging DC Volts Through Single Probe, Even With AC Coupled.
- Automatic Peak-To-Peak Volts - Even If Variable Control Is "Out Of Cal".
- Automatic Frequency Measurements Without Sensitivity Adjustment Or Range Switching.

Digital Delta Tests Analyze Any Part Of The Signal.

- Delta Peak-To-Peak Volts - Peak-To-Peak Volts Of Any Part Of The Signal.
- Delta Time For Any Time Reading - Including Delay Between Traces
- 1/Delta Time - Frequency Of Part Of The Signal - Finds Sources Of Interference Or Ringing.

Frequency Ratio Test - Tests Multiplier And Divider Circuits

Easy To Use - Human Engineered Controls And Virtually No Graticule Counting Or Calculations

The SC61 is designed to give you the measurements you need - fast. We make one claim:

"Try the SC61 on your bench for 30 days. If it doesn't cut your present scope time in half, send it back for a complete refund, no questions asked."

Try the SC61 for 30 days, and discover true troubleshooting speed.

**Call 1-800-843-3338
In Canada Call 1-800-851-8866**

Circle (2) on Reply Card

SENCORE

For your own reputation
and in your customers' best interest
always insist on

Genuine Zenith
Remanufactured Replacement Parts
Reconditioned and Serviced for Reliability
by Zenith People
as Knowledgeable and Dedicated as
Those Who Made the Originals!

One of the easiest, fastest, and surest ways for you to preserve the pedigree and maintain the quality of the Zenith products you service is with genuine Zenith replacement parts.

And at no time is this more critical than when you replace the more sophisticated components like modules, tuners, channel selectors and sub-assemblies.

Your participating Zenith parts distributor will supply you with a replacement remanufactured, reconditioned and serviced for reliability by Zenith people as dedicated and knowledgeable as those who made the original.

Equally important, the replacement module or sub-assembly you receive in exchange from your Zenith parts distributor

will most likely incorporate any Zenith factory-made modifications in effect at the time of remanufacture.

And nowhere else but in a participating Zenith parts distributor's Exchange Program can you get assurance that a replacement incorporates Zenith factory up-dates!

To learn the location of the Zenith R&R Exchange Counter in your area, simply complete and send in the postage-free Reply Card inside this issue of *Electronic Servicing & Technology*.

Look inside, complete the Zenith Reply Card and chances are we'll prove Zenith factory-fresh replacement modules and sub-assemblies are closer and more readily available than you realize!



The quality goes in before the name goes on.®

Zenith Service, Parts & Accessories • 11000 Seymour Avenue, Franklin Park, Illinois 60131 • A Division of Zenith Electronics Corporation